

# Custom Passive Radiator Box Design

By CJJ, TB

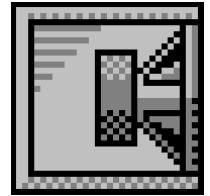

## Box Properties

--Description--

Name: W4-2089

Type: Passive Radiator Box

Shape: Prism, square

--Box Parameters--

Vb = 3 liters

V(total) = 3.361 liters

QL = 7

F3 = 66.77 Hz

Fill = minimal

--Passive Radiators--

No. of Passive Radiators = 1

Fs = 8.291 Hz

Qms = 2.005

Vas = 42.06 liters

Cms = 5.265 mm/N

Mms = 70 g

Rms = 1.818 kg/s

Sd = 74 sq.cm

## Driver Properties

--Description--

Name: W4-2089

Type: Standard one-way driver

--Configuration--

**No. of Drivers = 1**

--Mechanical Parameters--

Fs = 38 Hz

Qms = 4.6

Vas = 4 liters

Cms = 0.501 mm/N

Mms = 35.03 g

Rms = 1.818 kg/s

Xmax = 8 mm

Xmech = 12 mm

P-Dia = 97.72 mm

Sd = 75 sq.cm

P-Vd = 0.06 liters

--Electrical Parameters--

Qes = 0.35

Re = 3.6 ohms

Le = 0.2 mH

Z = 4 ohms

BL = 9.276 Tm

Pe = 40 watts

--Electromech. Parameters--

Qts = 0.325

no = 0.0605 %

1-W SPL = 80.01 dB

2.83-V SPL = 83.48 dB



### Wiring Diagram

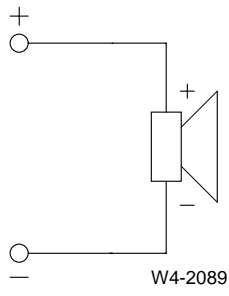

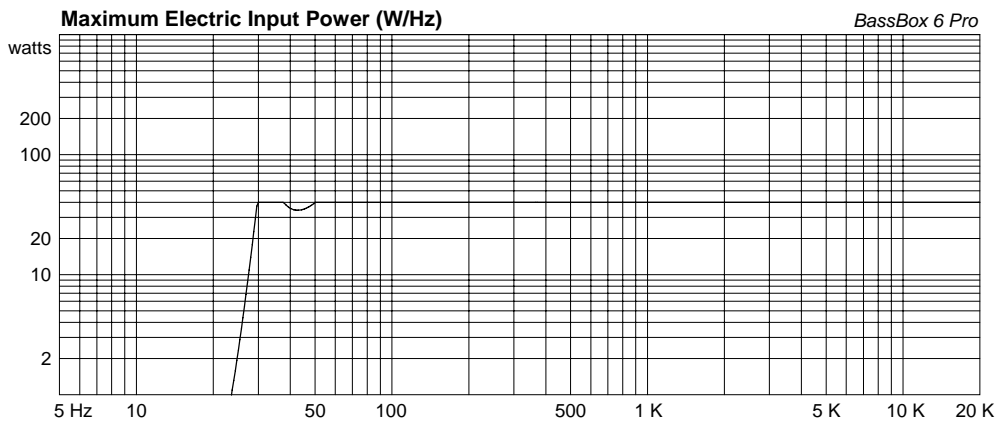
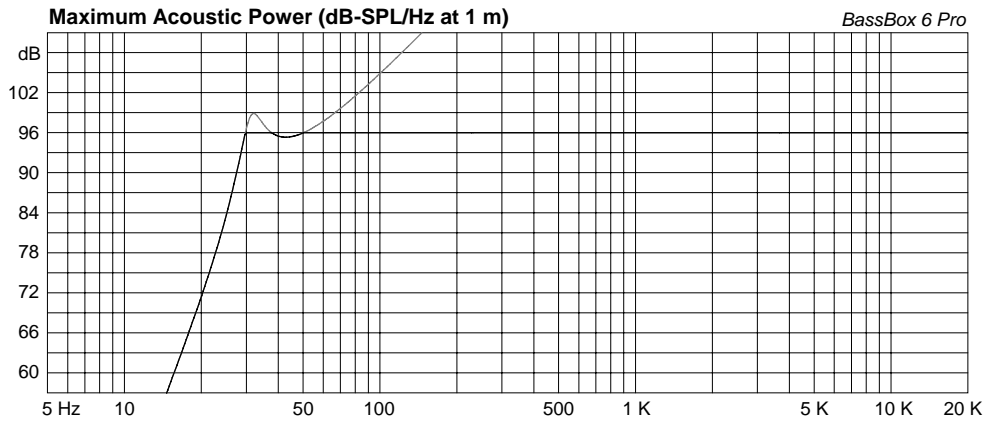
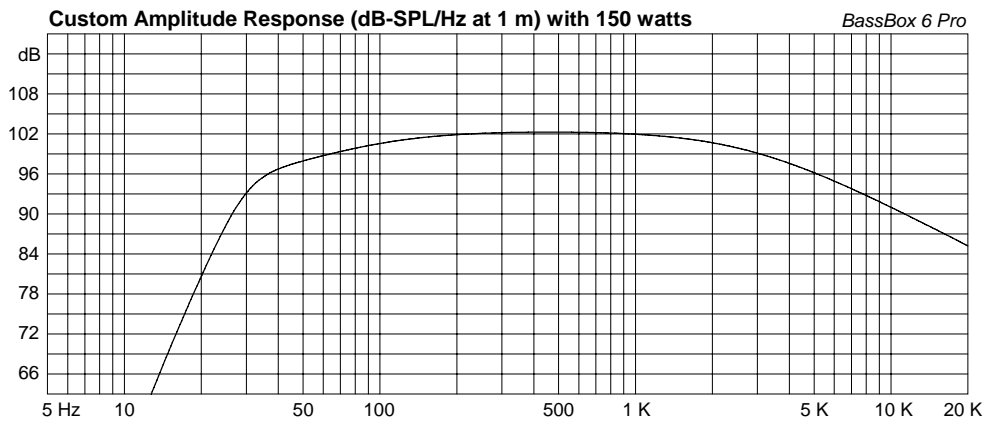
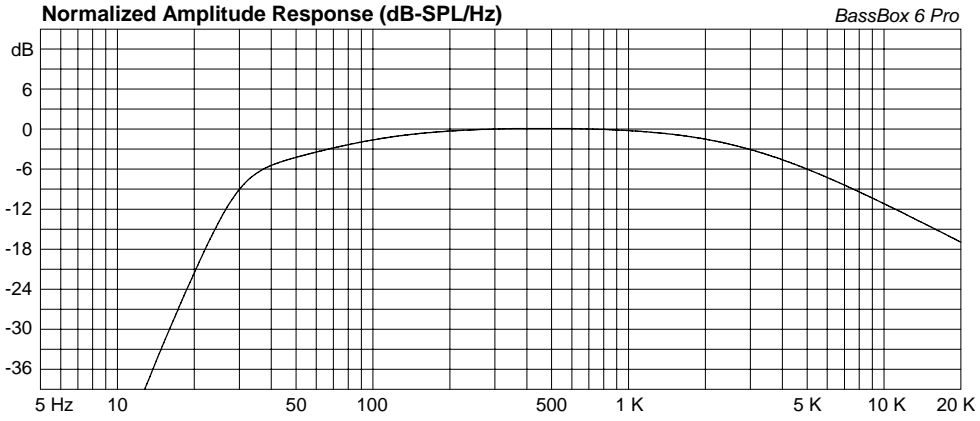

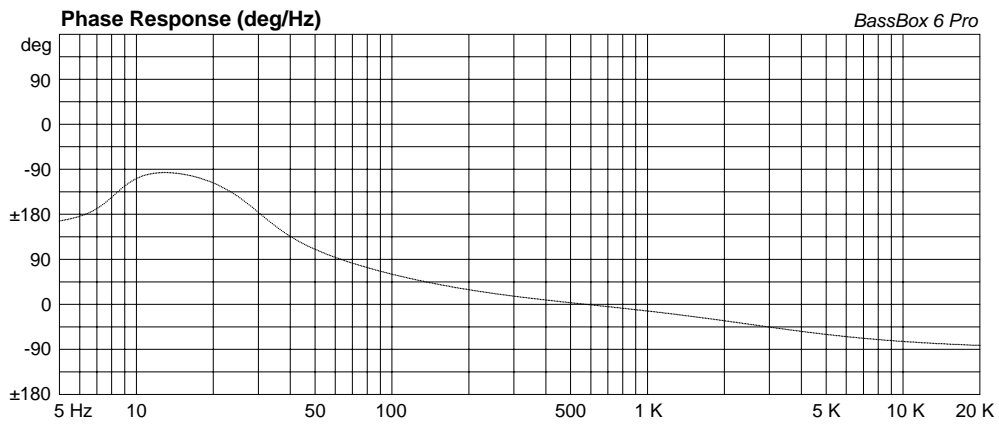
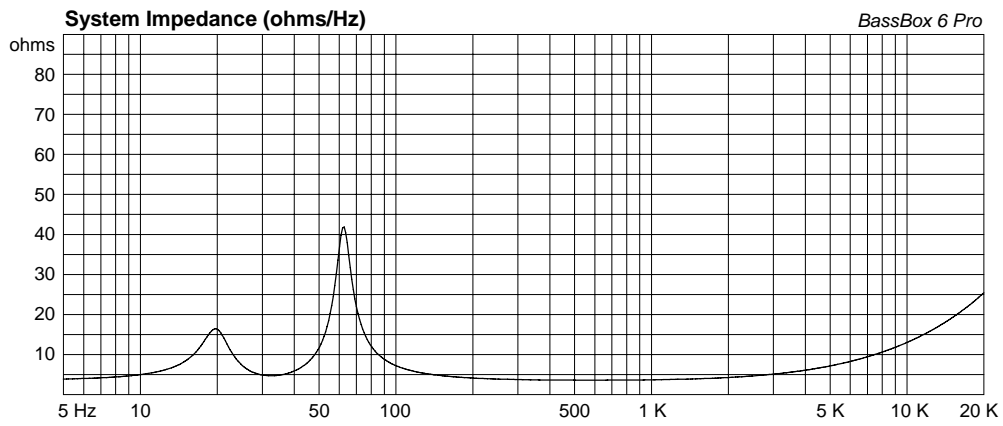
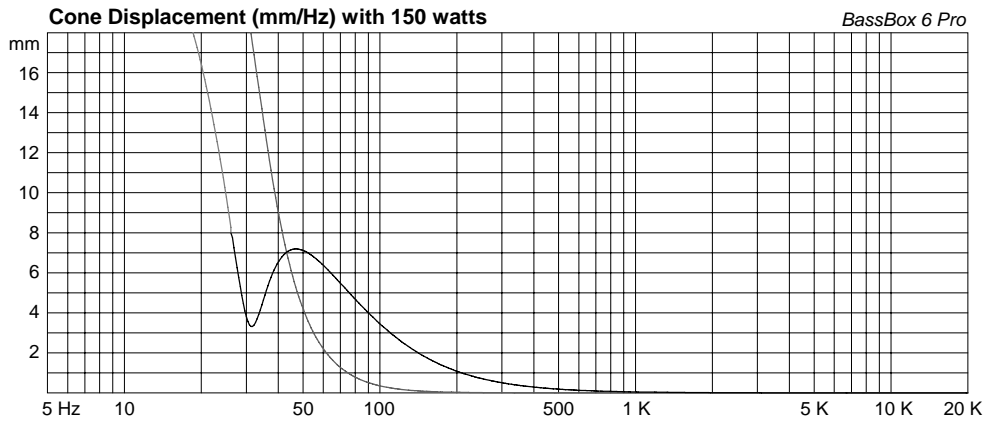

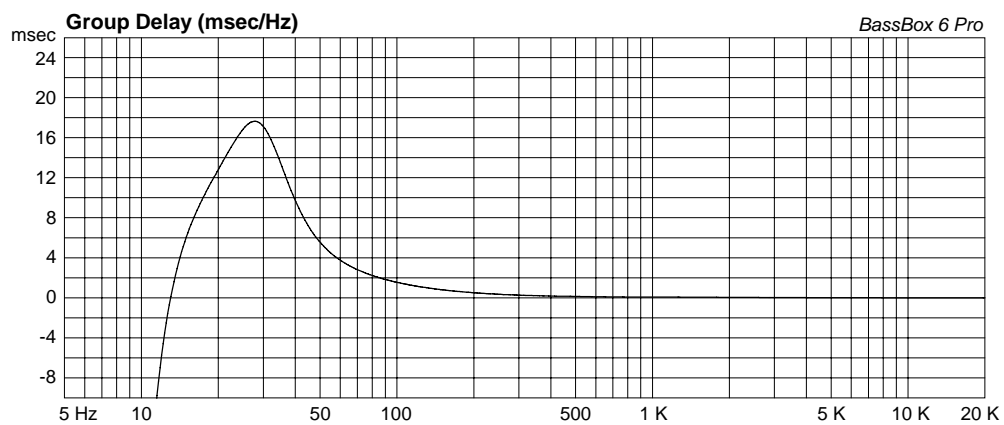

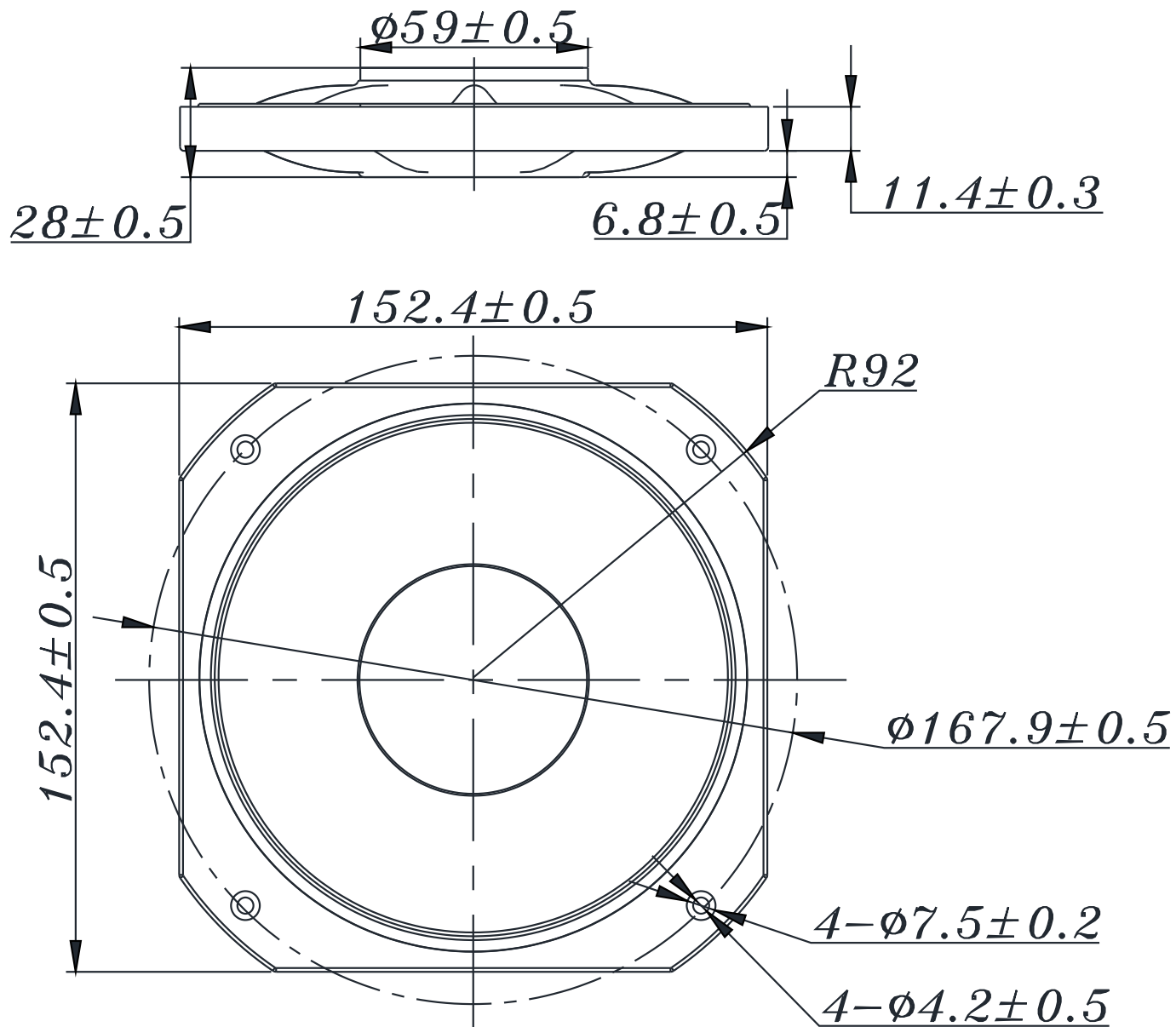

Material(材质):Rubber

**TS**  
speaker

**PR15**

Rev:R03

Date: 2020-05-20