

Custom Passive Radiator Box Design

By CJJ, A

Box Properties

--Description--

Name: W2-2040S

Type: Passive Radiator Box

Shape: Prism, square

--Box Parameters--

Vb = 0.5 liters

V(total) = 0.573 liters

QL = 7

F3 = 63.57 Hz

Fill = minimal

--Passive Radiators--

No. of Passive Radiators = 2

Fs = 18.56 Hz

Qms = 1.971

Vas = 2.673 liters

Cms = 7.351 mm/N

Mms = 10 g

Rms = 0.592 kg/s

Sd = 16 sq.cm

Driver Properties

--Description--

Name: W2-2040S

Type: Standard one-way driver

--Configuration--

No. of Drivers = 1

--Driver Parameters--

Fs = 72 Hz

Qms = 5.2

Vas = 0.2 liters

Xmax = 5.3 mm

Sd = 14 sq.cm

Qes = 0.27

Re = 3.5 ohms

Le = 0.246 mH

Z = 4 ohms

Pe = 10 watts

Wiring Diagram

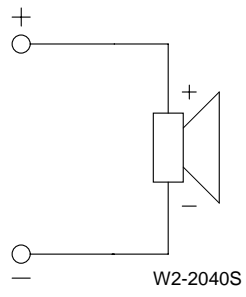

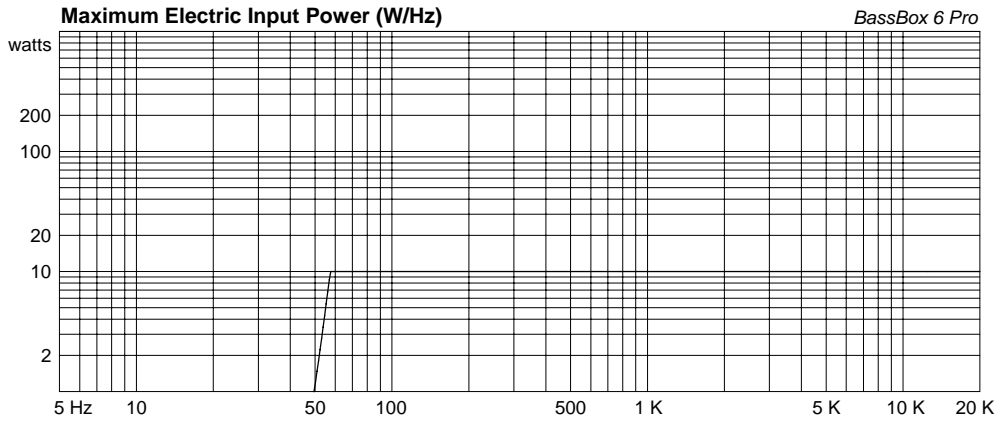
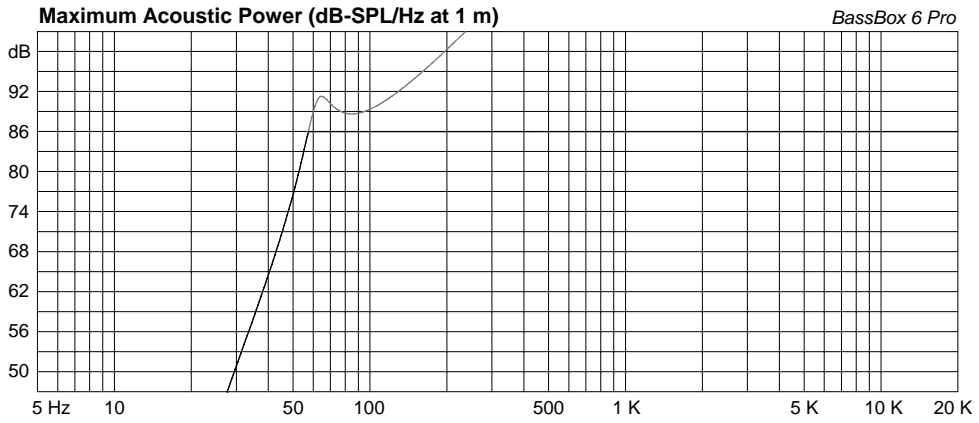
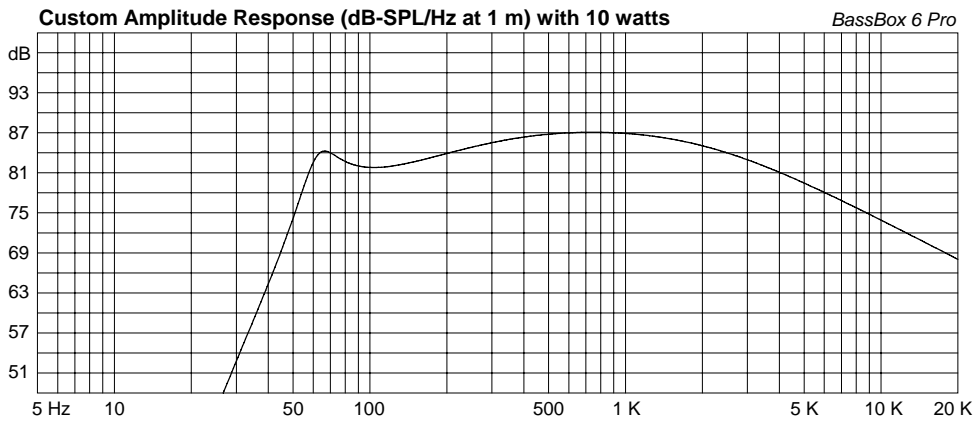
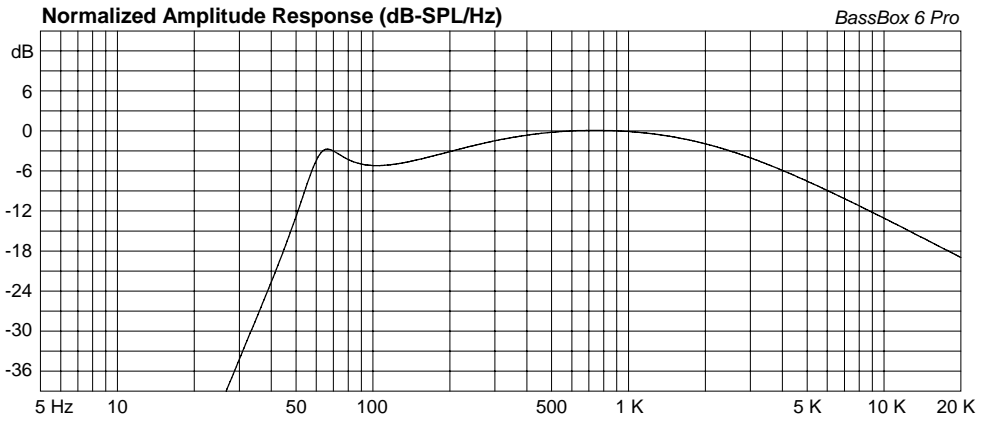

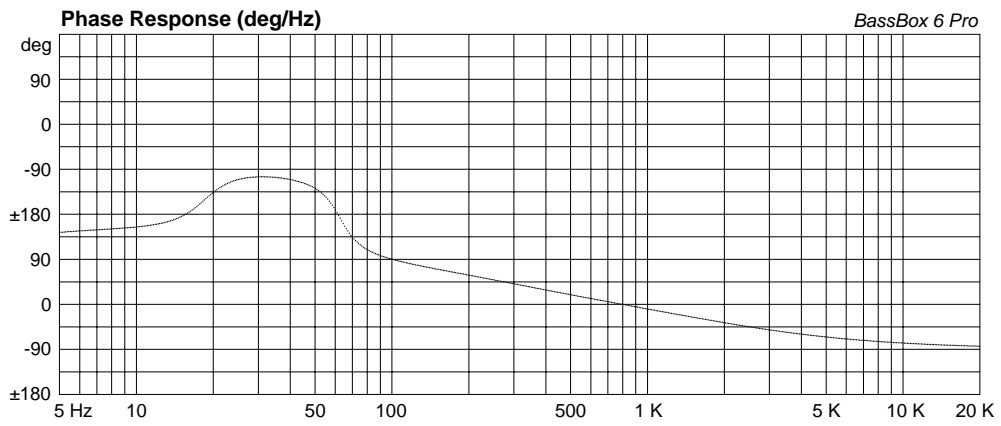
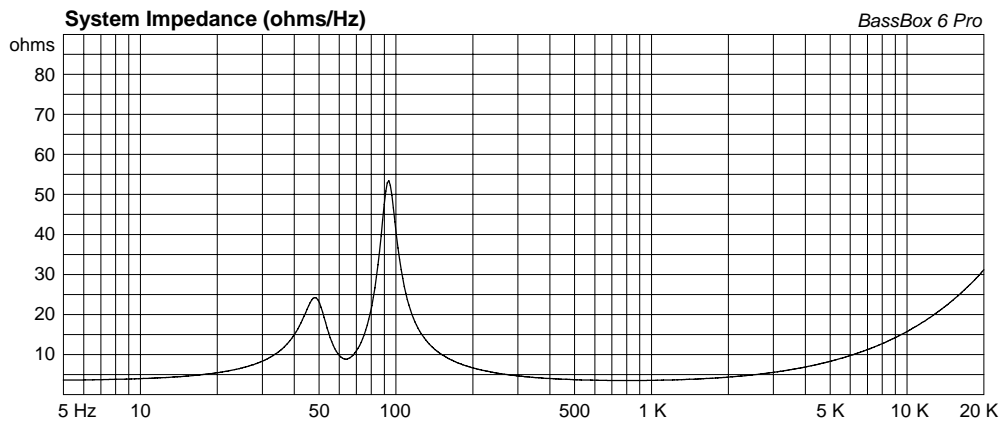
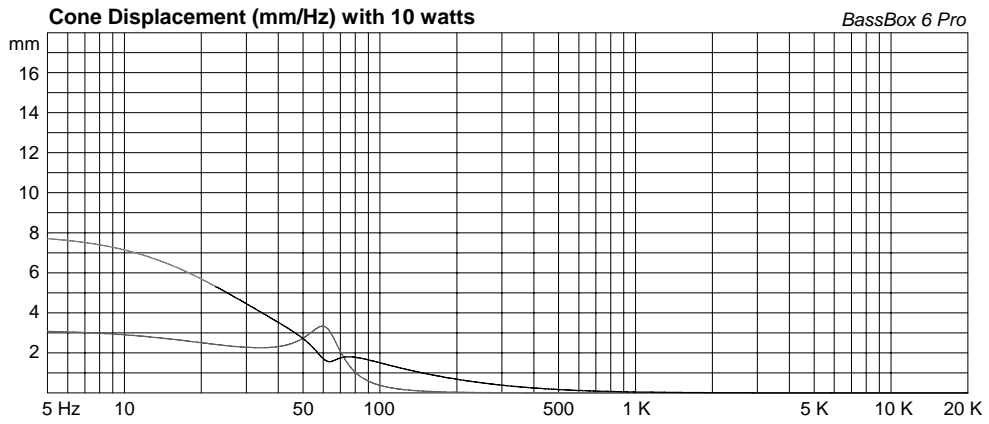

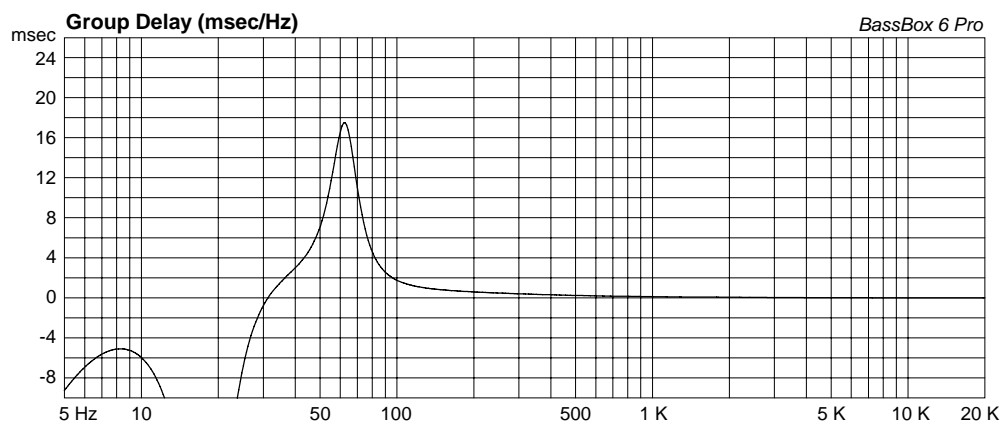

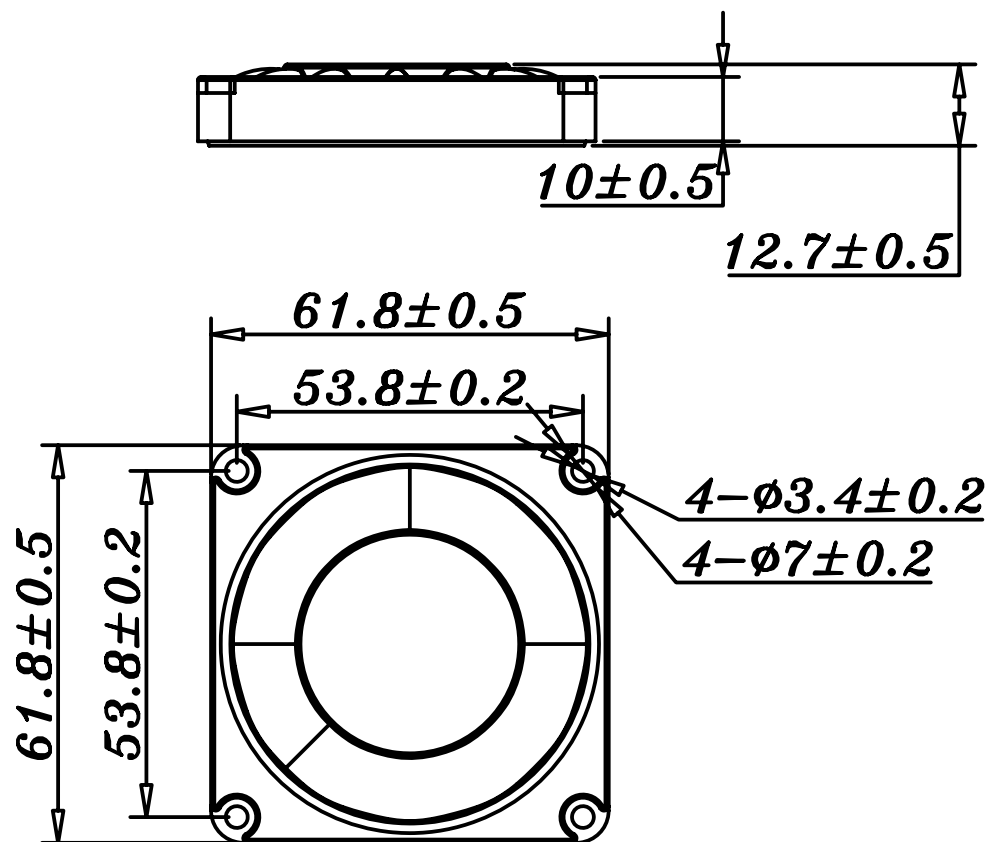

Material(材质):Rubber

TS
speaker

PR07

Rev:R01

Date : 2015-09-07