

Box Properties

--Description--

Name: W6-2100

Type: Passive Radiator Box

Shape: Prism, square (optimum)

--Box Parameters--

Vb = 14 liters

V(total) = 14.09 liters

QL = 7

F3 = 29.01 Hz

Fill = minimal

--Passive Radiators--

No. of Passive Radiators = 1

Fs = 7.531 Hz

Qms = 5.915

Vas = 228.3 liters

Cms = 1.786 mm/N

Mms = 260 g

Rms = 2 kg/s

Sd = 300 sq.cm

Driver Properties

--Description--

Name: W6-2100

Type: Standard one-way driver

--Configuration--

No. of Drivers = 1

--Driver Parameters--

Fs = 30 Hz

Qms = 5.2

Vas = 16.22 liters

Xmax = 10 mm

Sd = 176 sq.cm

Qes = 0.48

Re = 3.6 ohms

Le = 0.157 mH

Z = 4 ohms

Pe = 55 watts

Wiring Diagram

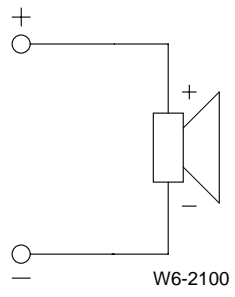

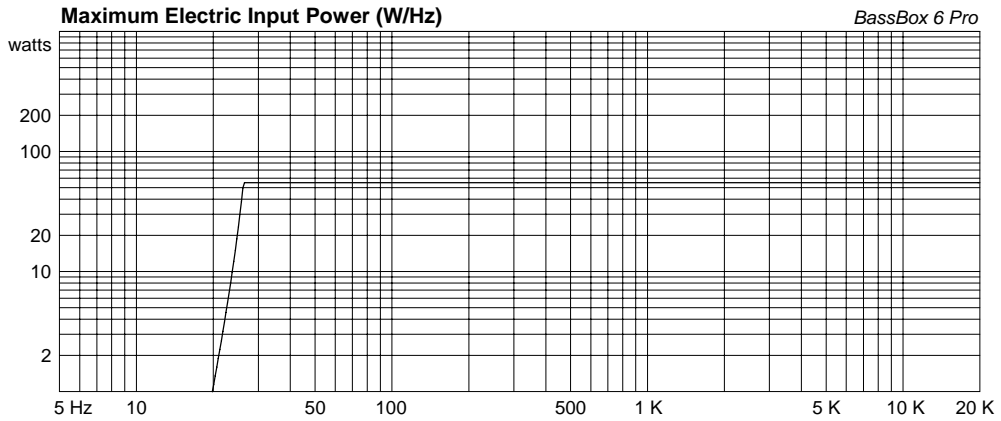
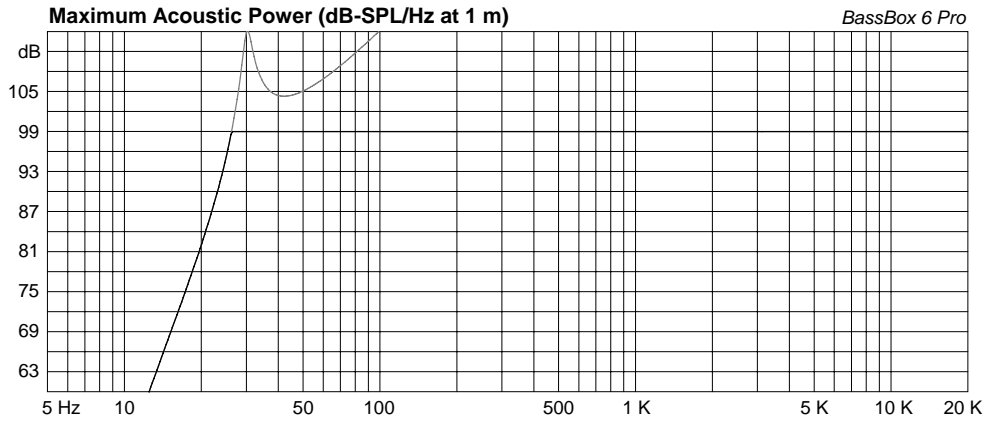
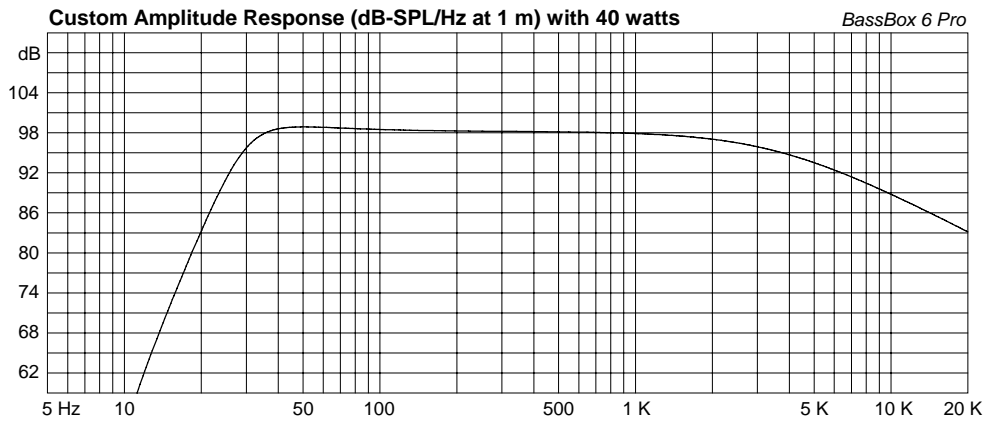
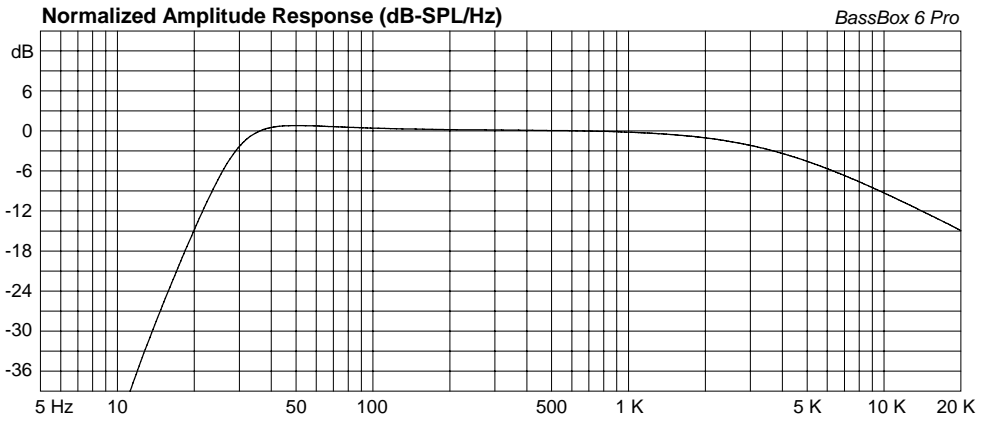

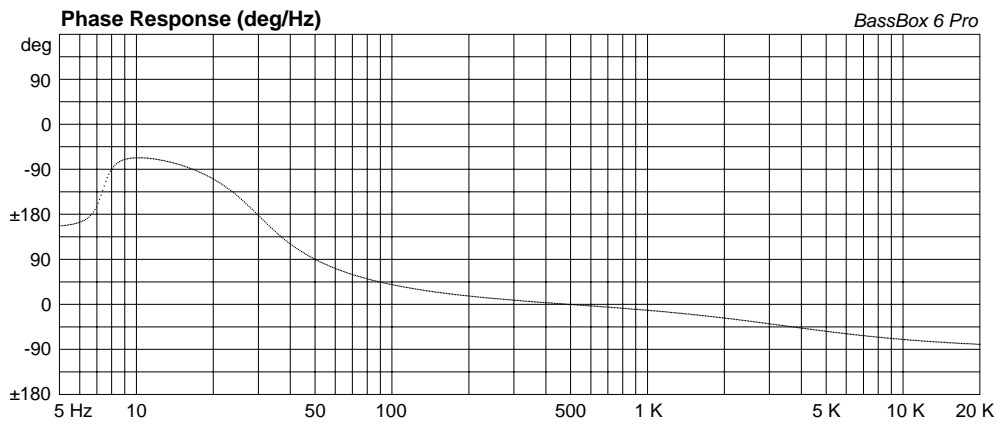
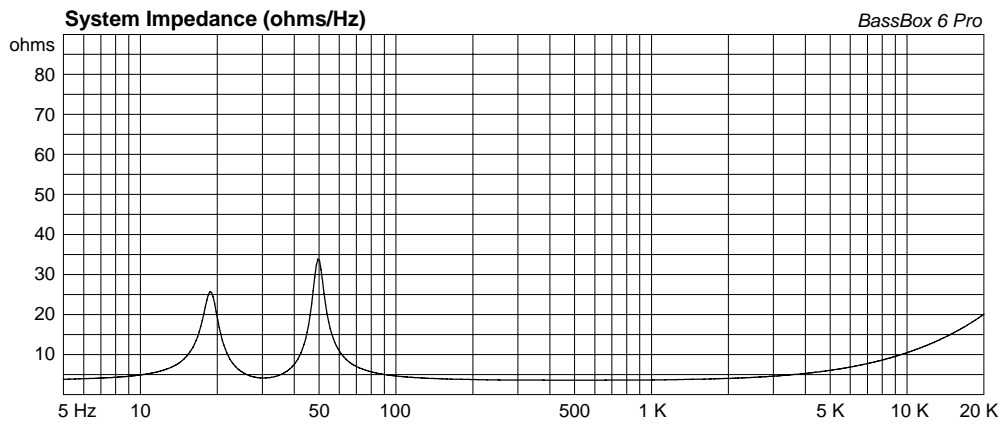
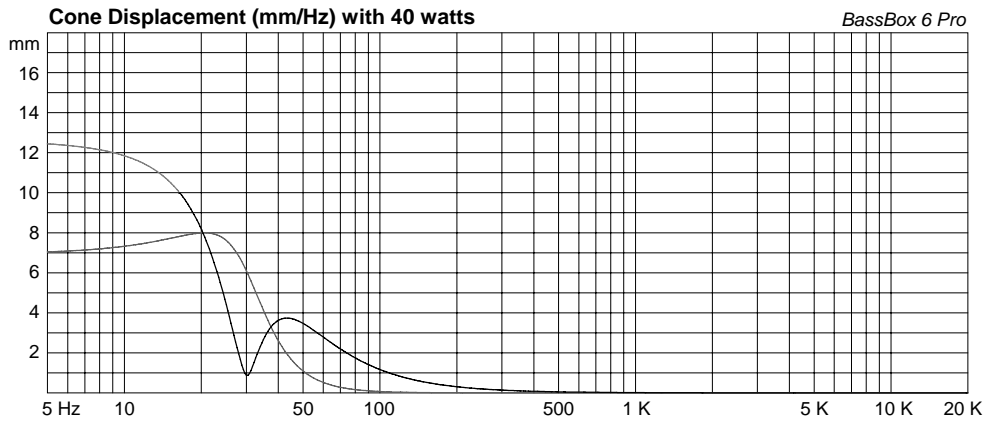

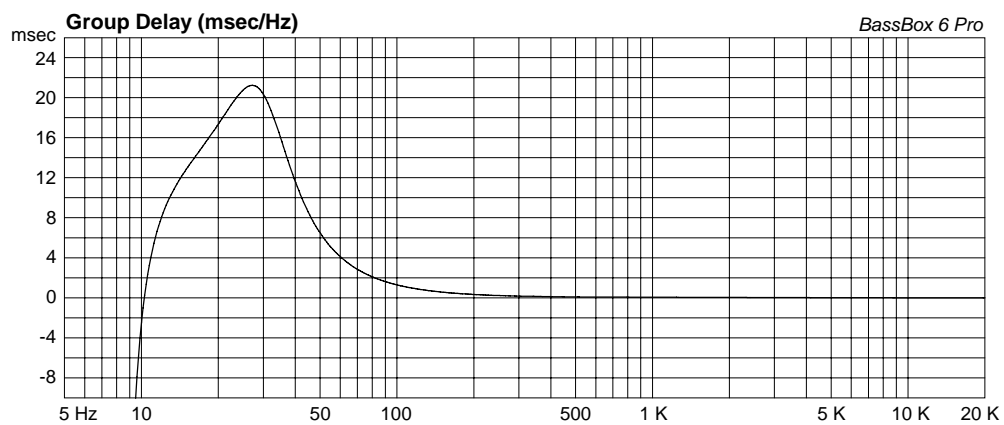

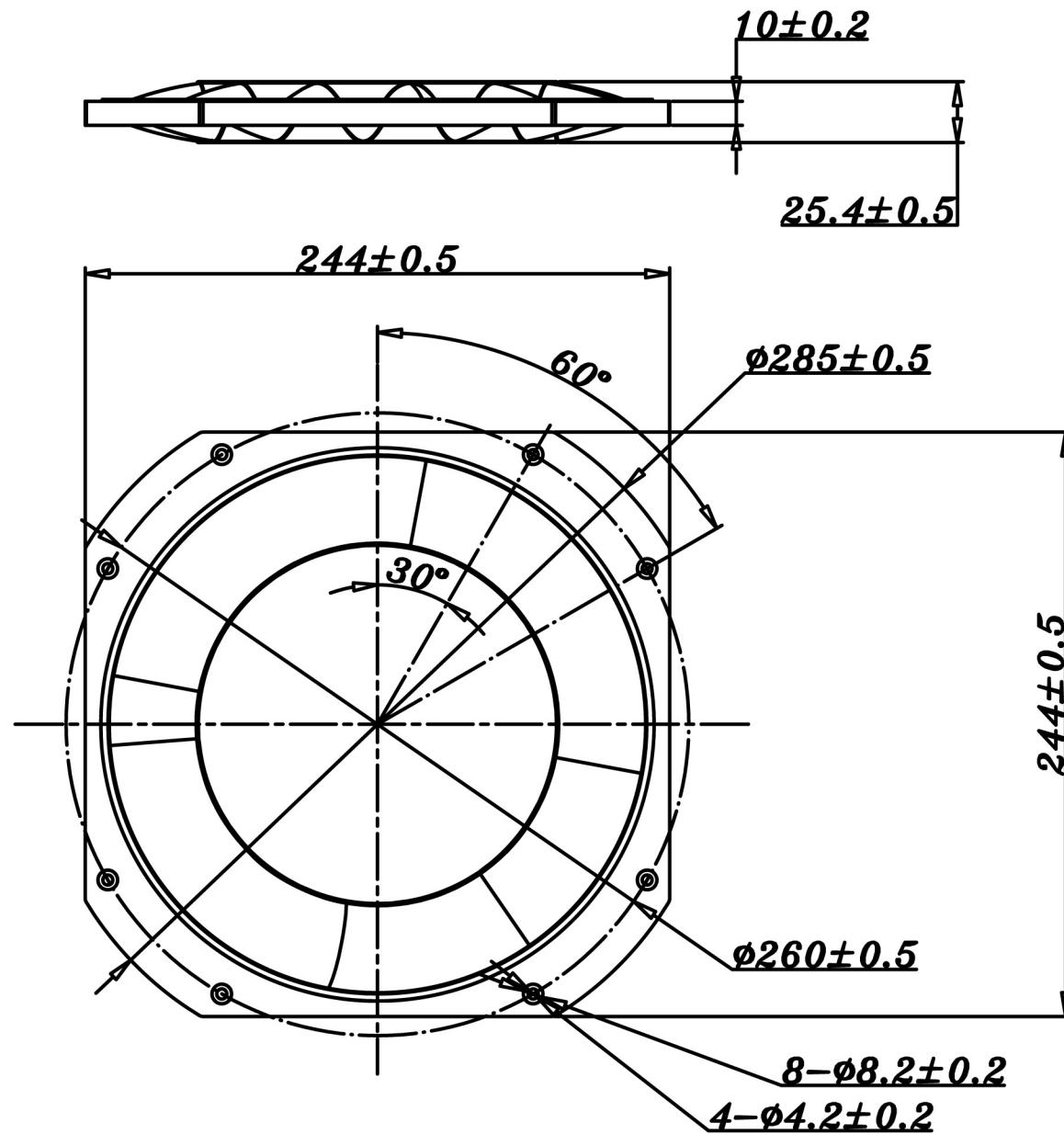

Material(材质):Rubber

TS
speaker

PR09

Rev:R01

Date : 2015-09-07