

# Custom Passive Radiator Box Design

By CJJ, A

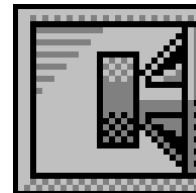

## Box Properties

--Description--

Name: W3-2108

Type: Passive Radiator Box

Shape: Prism, square

--Box Parameters--

Vb = 2.5 liters

V(total) = 2.706 liters

QL = 7

F3 = 40.19 Hz

Fill = minimal

--Passive Radiators--

No. of Passive Radiators = 1

Fs = 7.342 Hz

Qms = 2.747

Vas = 53.63 liters

Cms = 6.713 mm/N

Mms = 70 g

Rms = 1.175 kg/s

Sd = 75 sq.cm

## Driver Properties

--Description--

Name: W3-2108

Type: Standard one-way driver

--Configuration--

**No. of Drivers = 1**

--Mechanical Parameters--

Fs = 47 Hz

Qms = 4.66

Vas = 1.7 liters

Cms = 0.618 mm/N

Mms = 18.55 g

Rms = 1.175 kg/s

Xmax = 7 mm

Xmech = 10.5 mm

P-Dia = 74.85 mm

Sd = 44 sq.cm

P-Vd = 0.0308 liters

--Electrical Parameters--

Qes = 0.5

Re = 3.6 ohms

Le = 0.2 mH

Z = 4 ohms

BL = 6.28 Tm

Pe = 25 watts

--Electromech. Parameters--

Qts = 0.452

no = 0.034 %

1-W SPL = 77.52 dB

2.83-V SPL = 80.99 dB



### Wiring Diagram

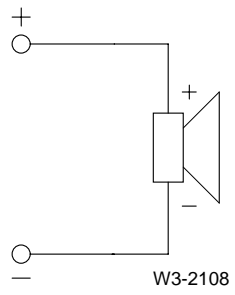

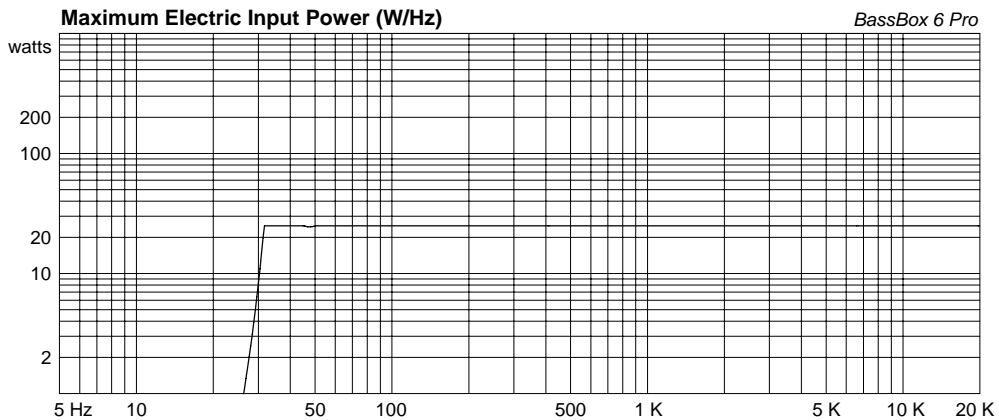
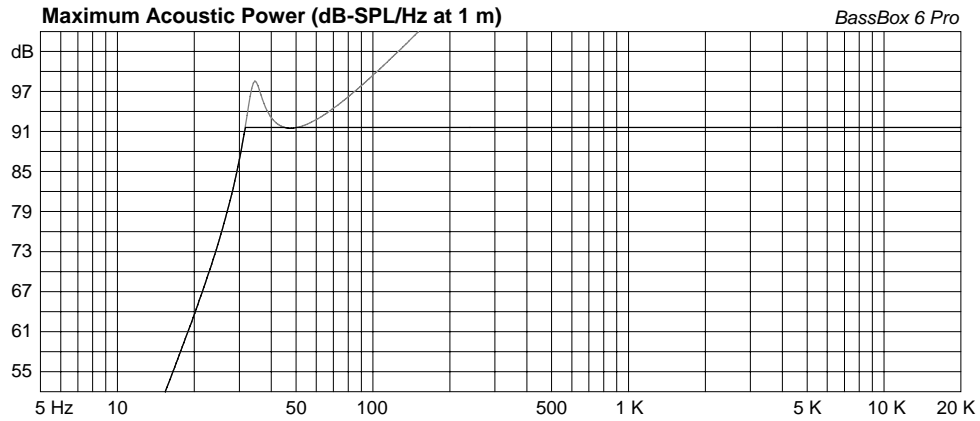
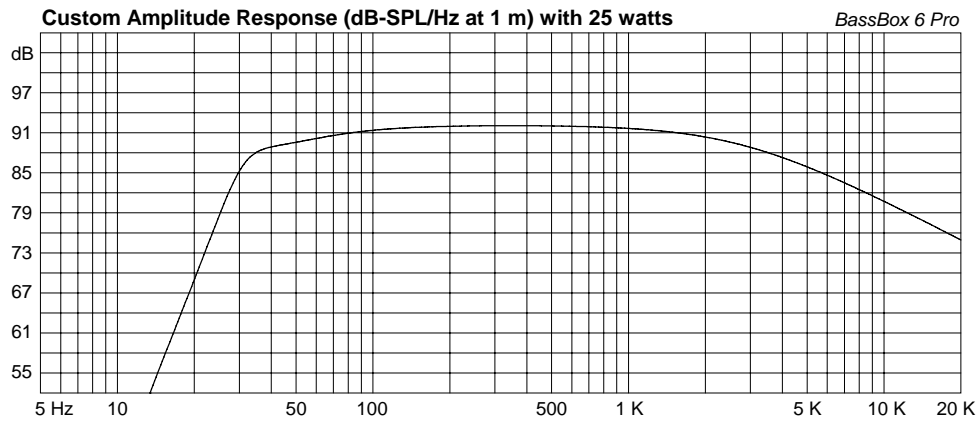
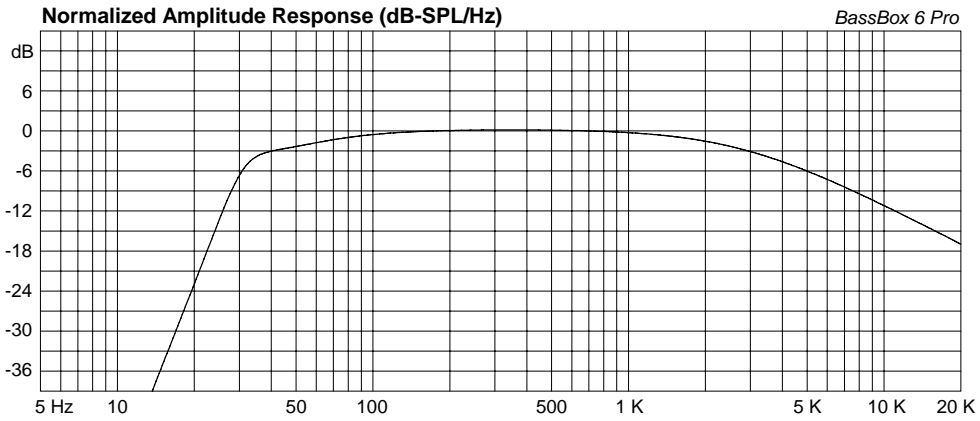

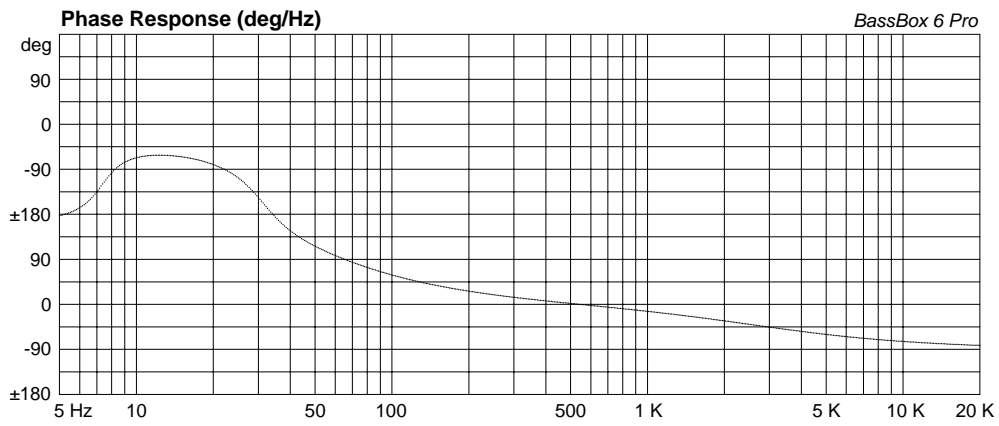
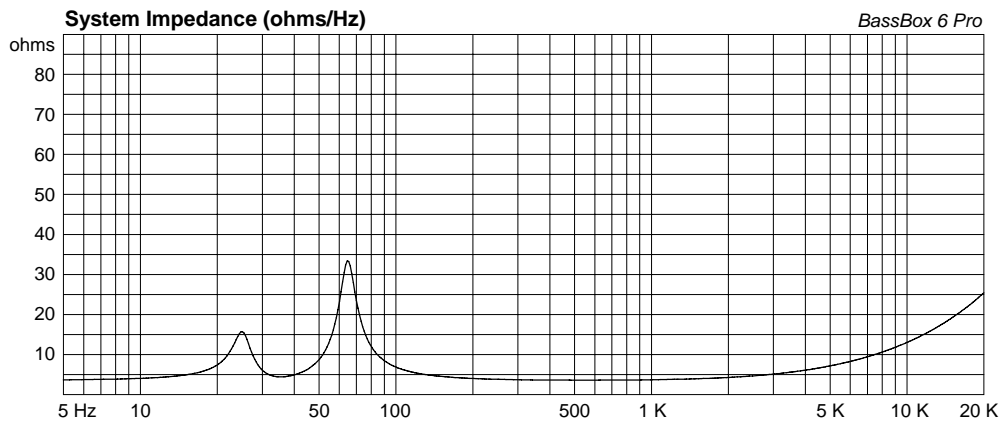
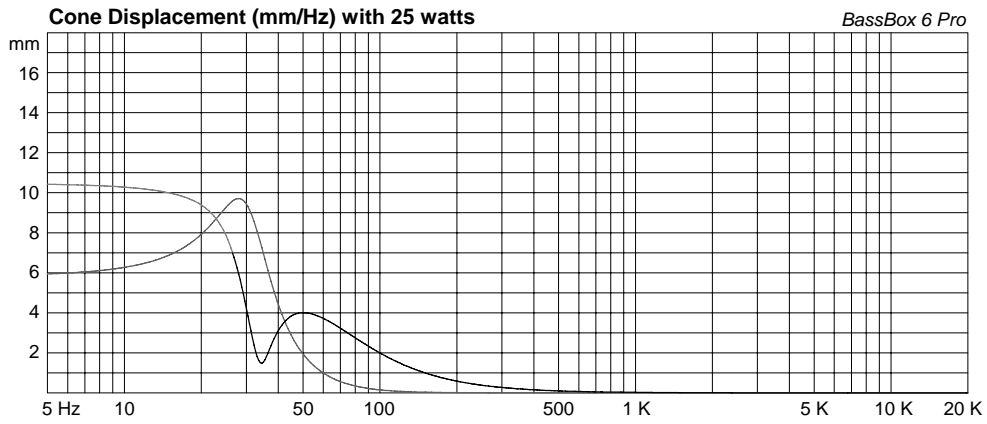

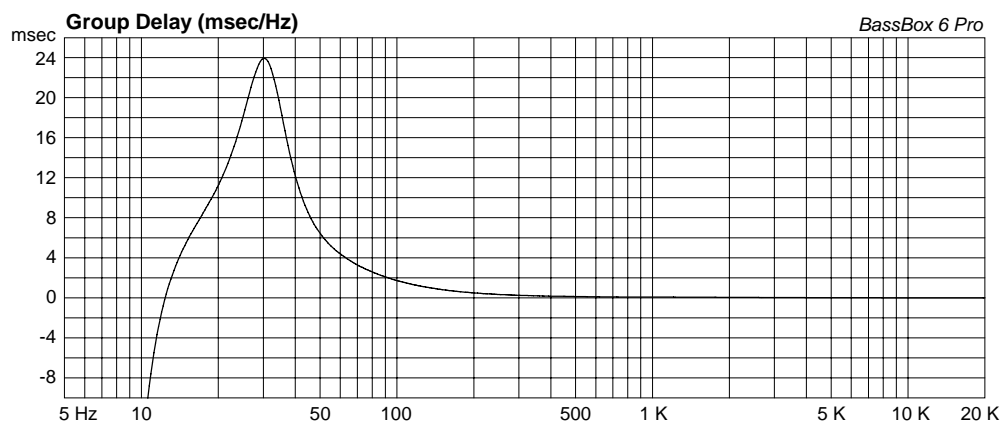

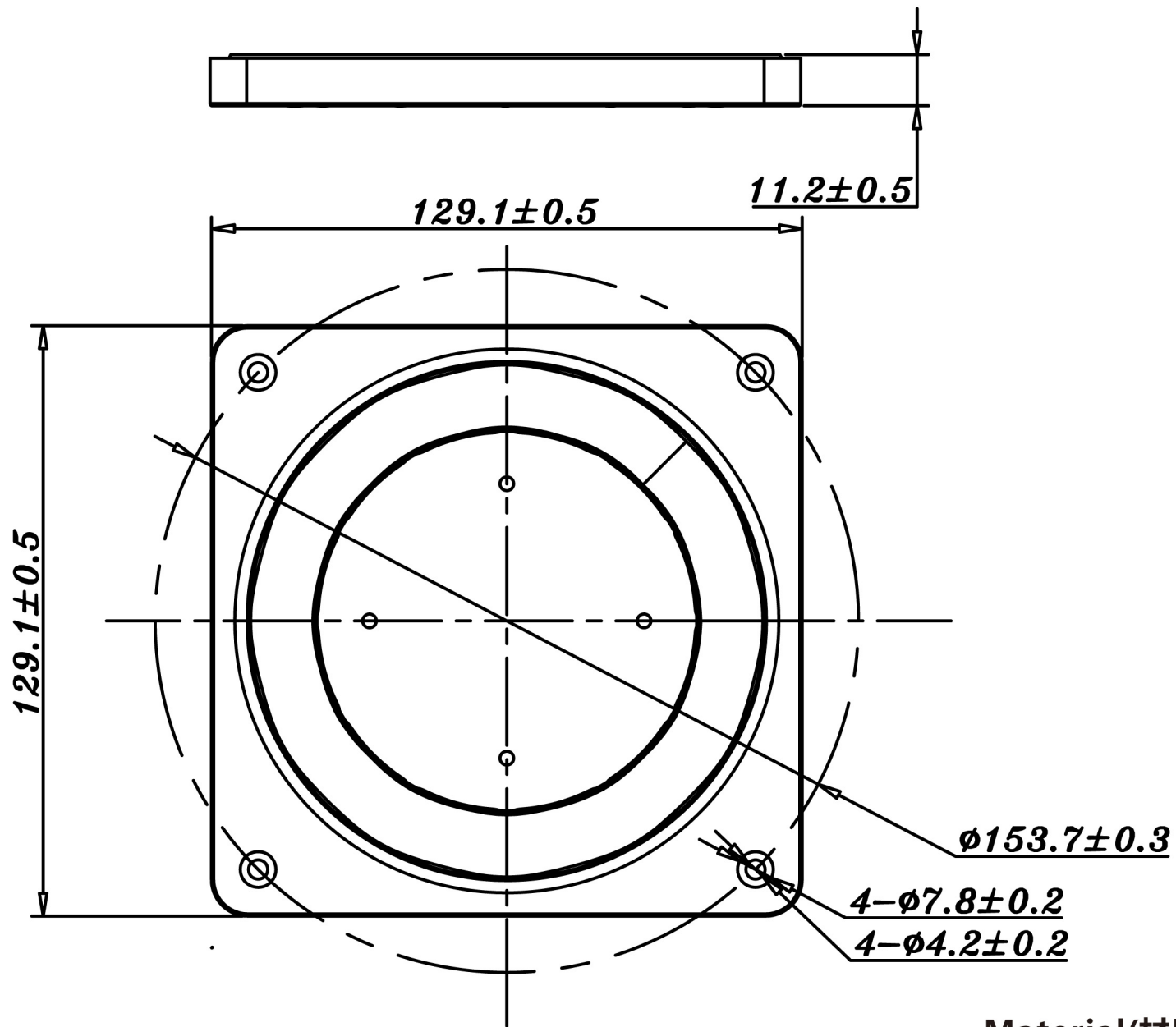

Material(材质):Rubber



PR13

Rev:R01

Date : 2015-09-07