

# Custom Passive Radiator Box Design

By 6059811B02517, 6059811B02517

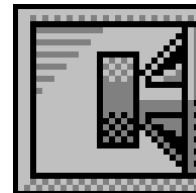

## Box Properties

--Description--

Name: PR14\*2

Type: Passive Radiator Box

Shape: Prism, square

--Box Parameters--

Vb = 9.211 liters

V(total) = 10.02 liters

QL = 7

F3 = 52.89 Hz

Fill = minimal

--Passive Radiators--

No. of Passive Radiators = 2

Fs = 15.75 Hz

Qms = 3.114

Vas = 16.26 liters

Cms = 1.703 mm/N

Mms = 60 g

Rms = 1.906 kg/s

Sd = 82 sq.cm

## Driver Properties

--Description--

Name: W6-1139SIF

Type: Standard one-way driver

--Configuration--

**No. of Drivers = 1**

--Driver Parameters--

Fs = 35 Hz

Qms = 4

Vas = 16.6 liters

Xmax = 11.5 mm

Sd = 140 sq.cm

Qes = 0.4

Re = 3.6 ohms

Le = 0.46 mH

Z = 4 ohms

Pe = 50 watts



### Wiring Diagram

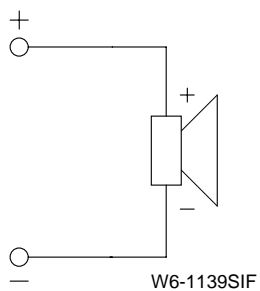

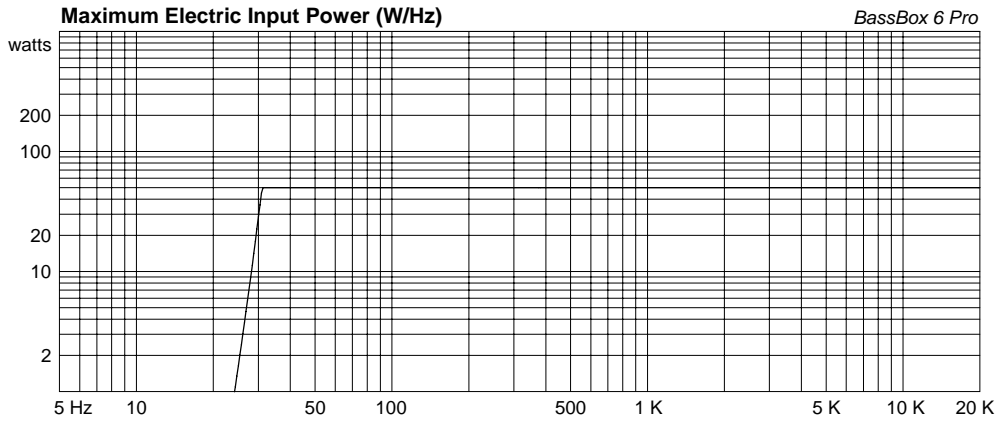
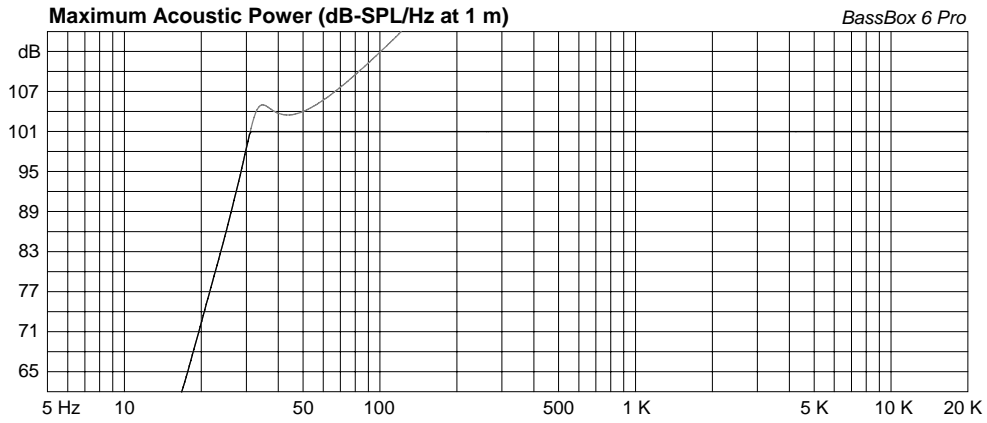
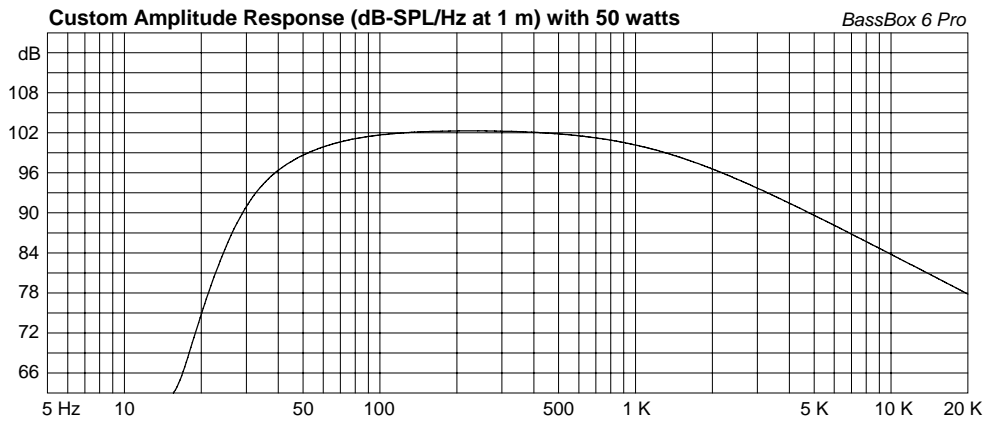
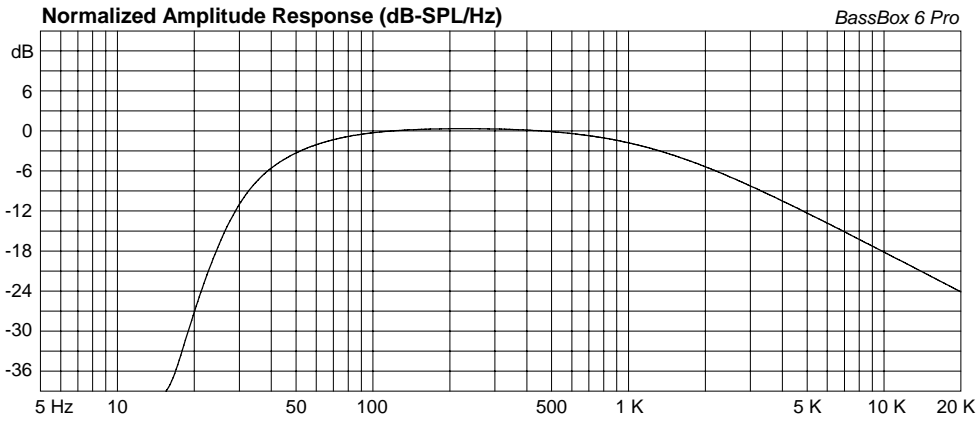

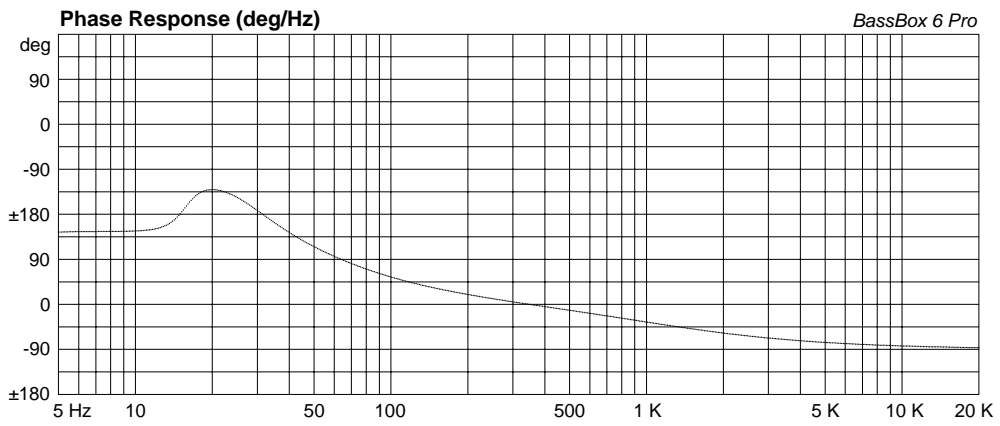
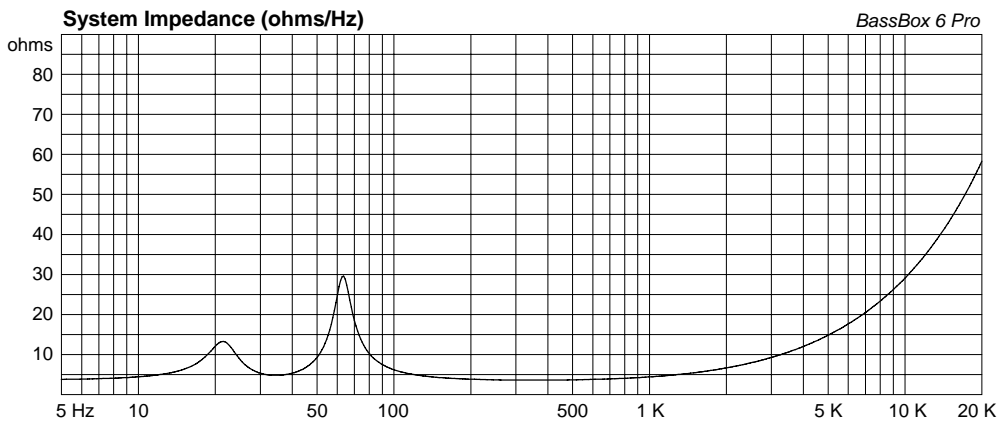
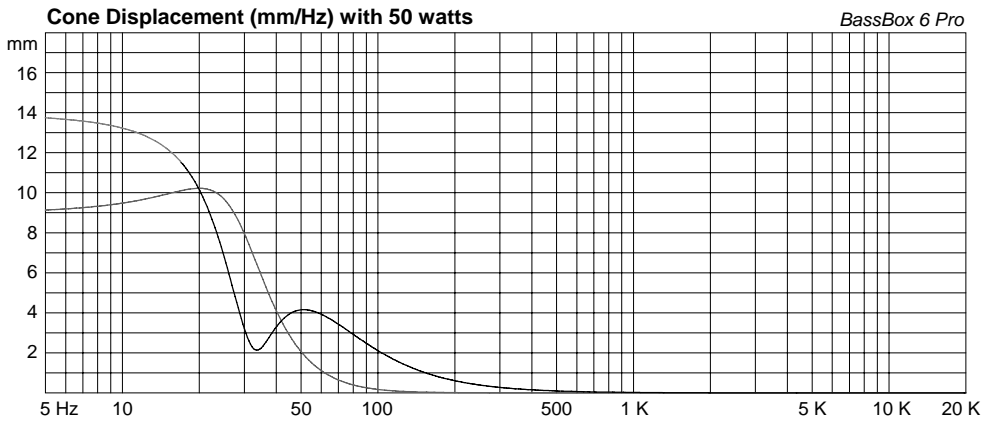

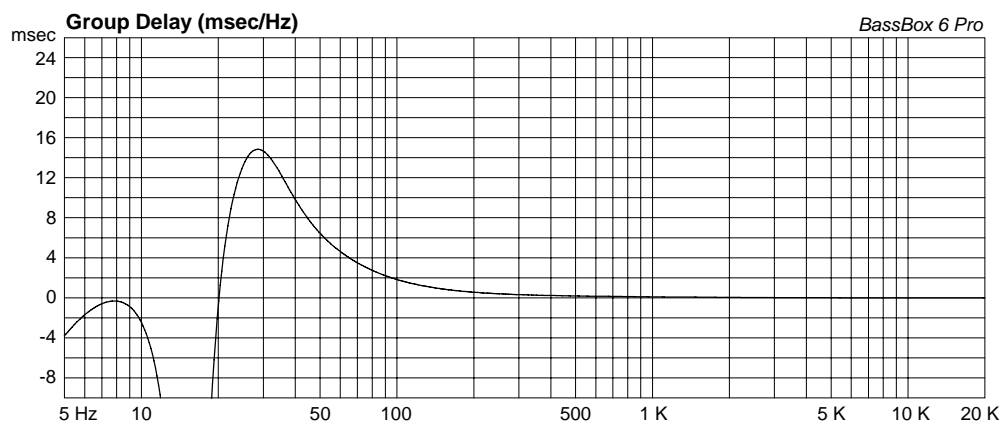

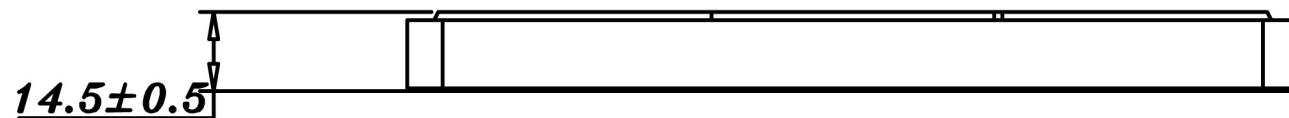
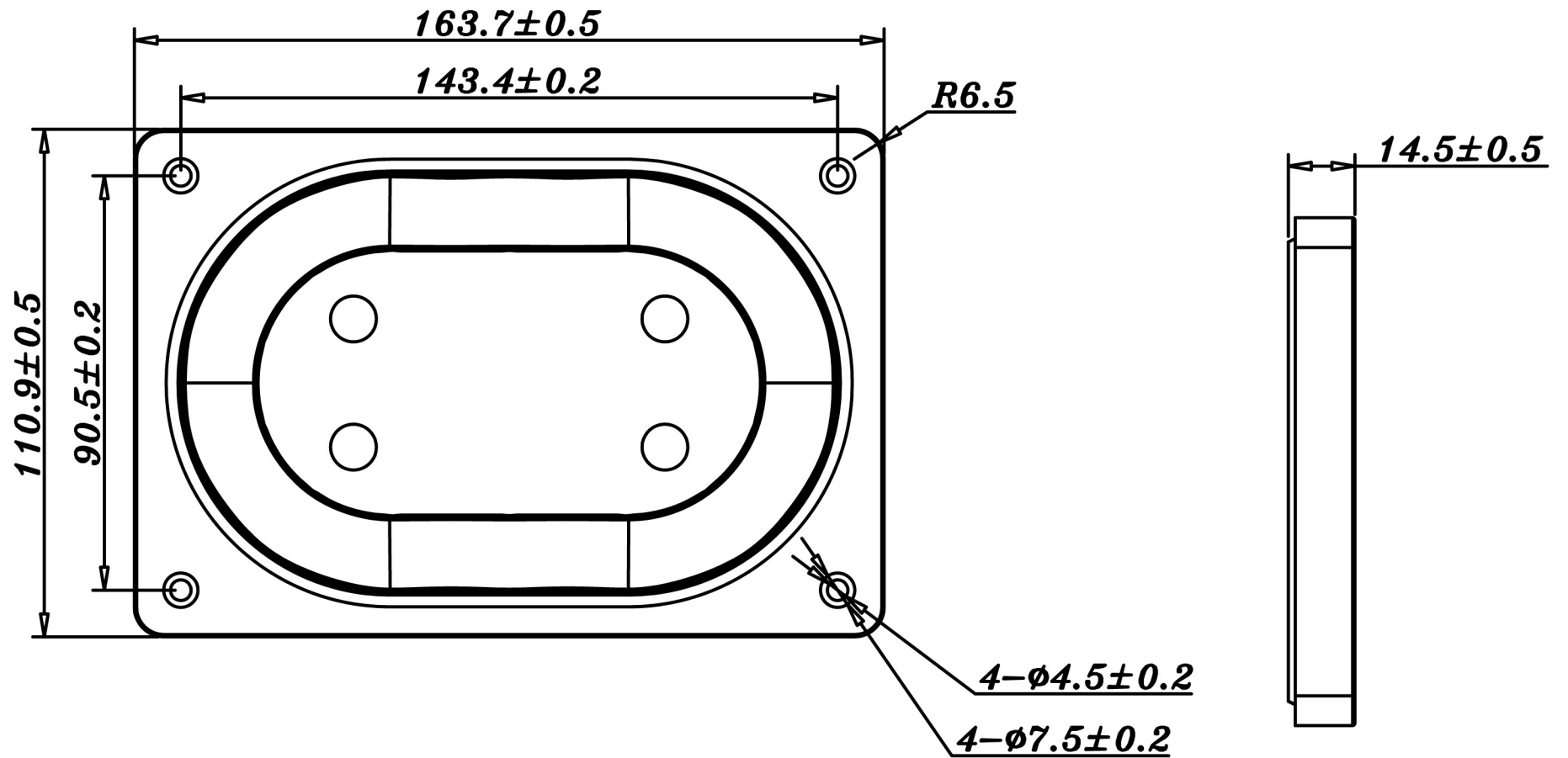

Material(材质):Rubber



PR14

Rev:R01

Date : 2015-09-07