

---

## Box Properties

--Description--

Name: PR14

Type: Passive Radiator Box

Shape: Prism, square

--Box Parameters--

Vb = 7.423 liters

V(total) = 7.887 liters

QL = 7

F3 = 48.51 Hz

Fill = minimal

--Passive Radiators--

No. of Passive Radiators = 1

Fs = 20.14 Hz

Qms = 1.898

Vas = 19.88 liters

Cms = 2.082 mm/N

Mms = 30 g

Rms = 2 kg/s

Sd = 82 sq.cm

## Driver Properties

--Description--

Name: W5-1138SMF

Type: Standard one-way driver

--Configuration--

**No. of Drivers = 1**

--Driver Parameters--

Fs = 47.6 Hz

Qms = 3.5

Vas = 4.8 liters

Xmax = 9.25 mm

Sd = 94 sq.cm

Qes = 0.57

Re = 3.4 ohms

Le = 0.34 mH

Z = 4 ohms

Pe = 40 watts



### Wiring Diagram

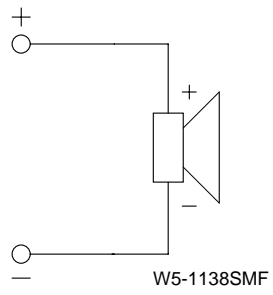

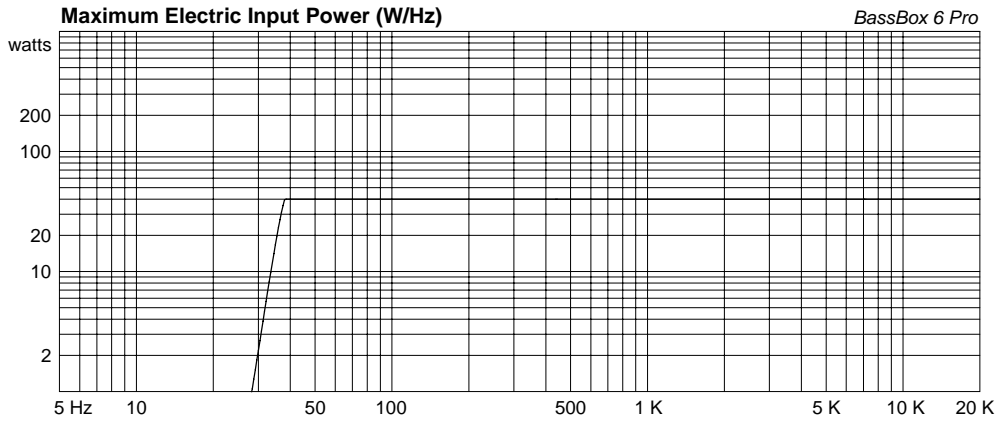
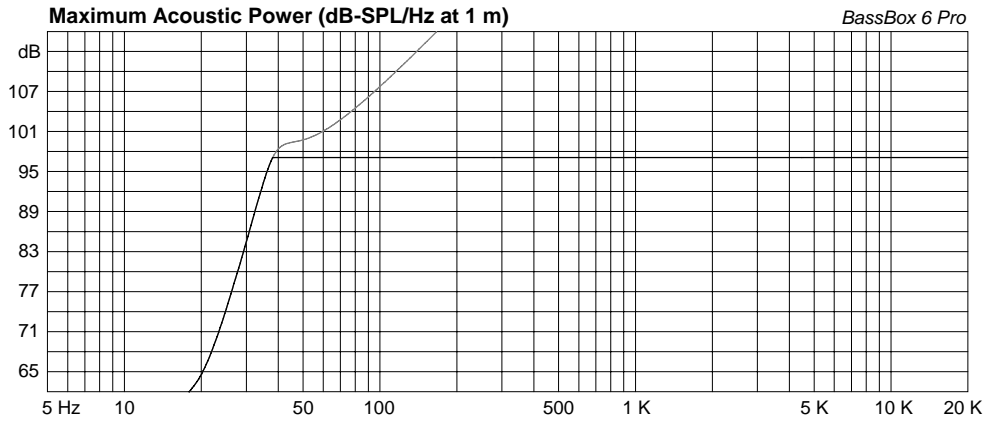
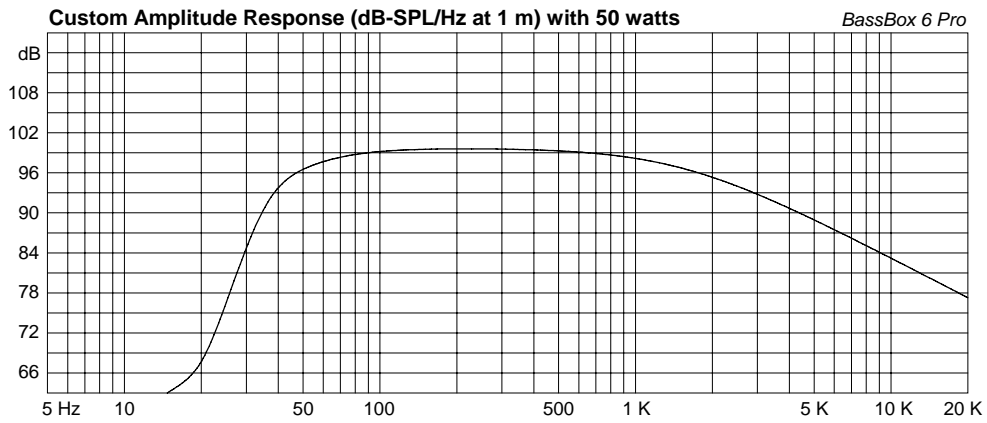
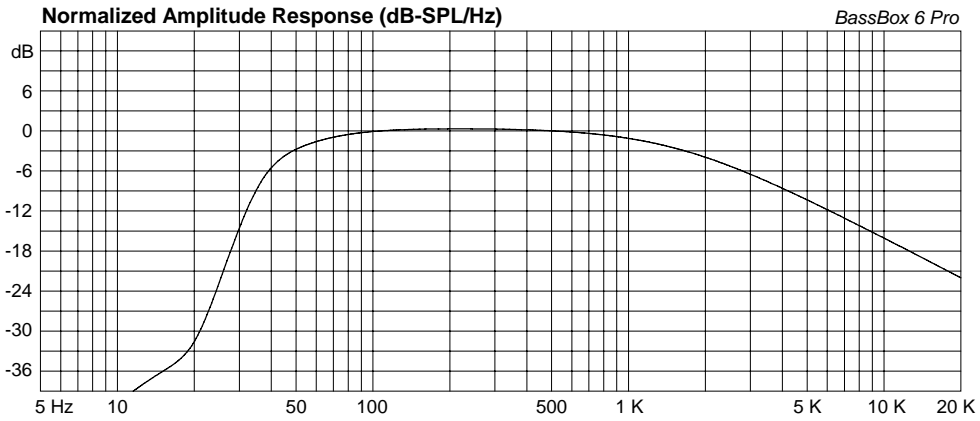

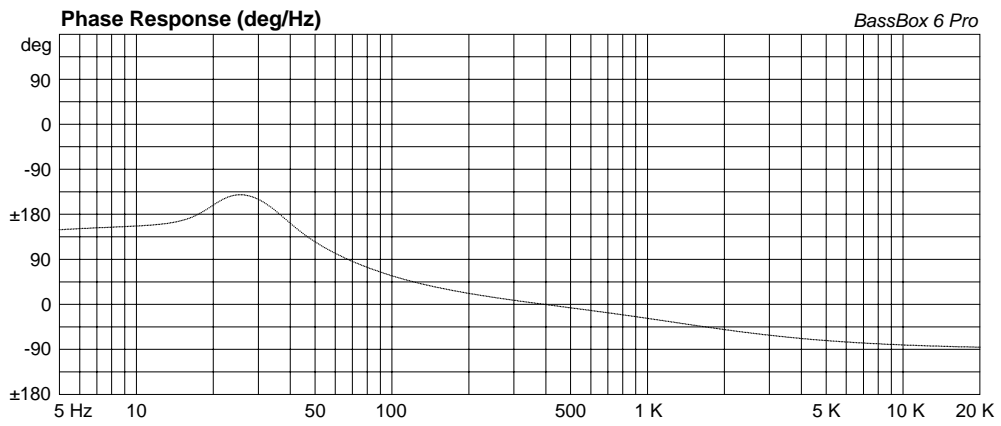
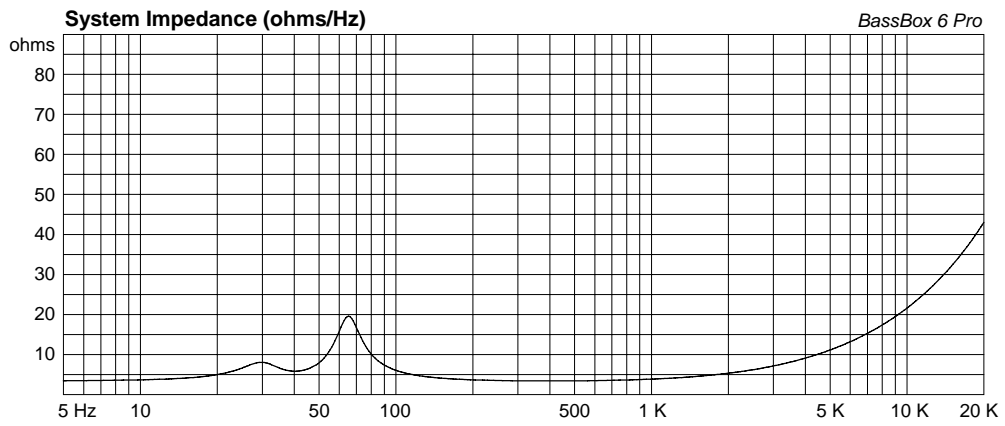
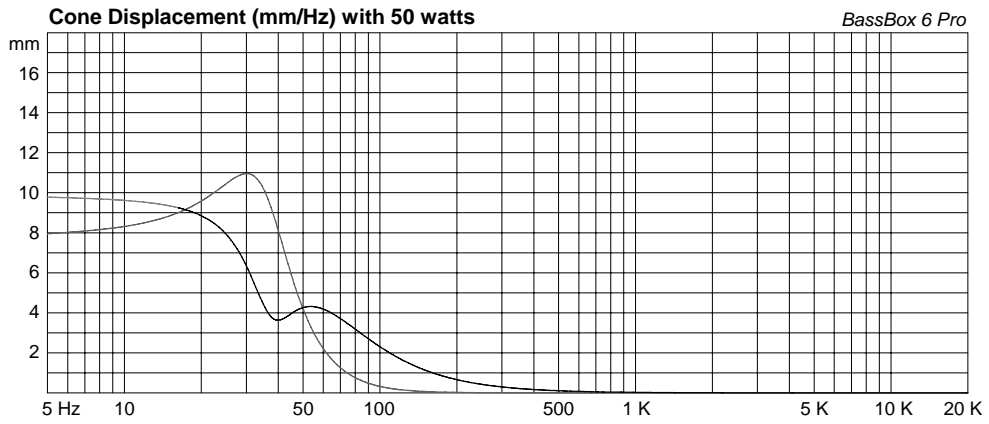

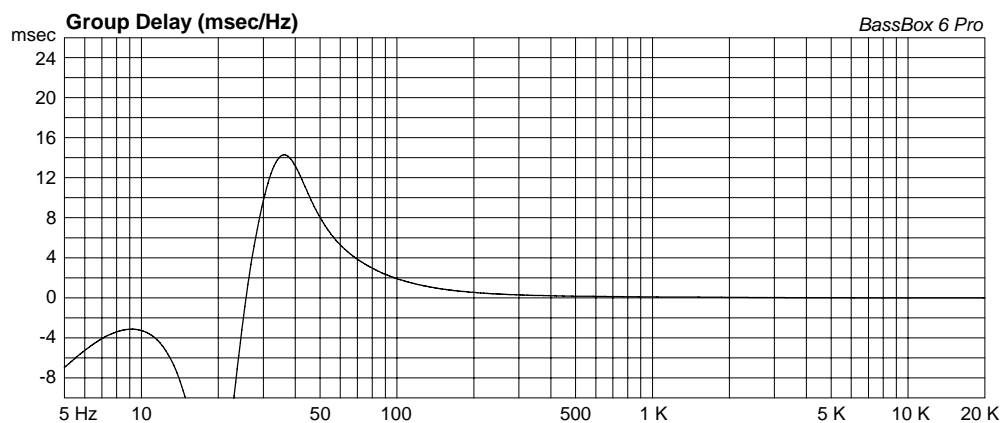

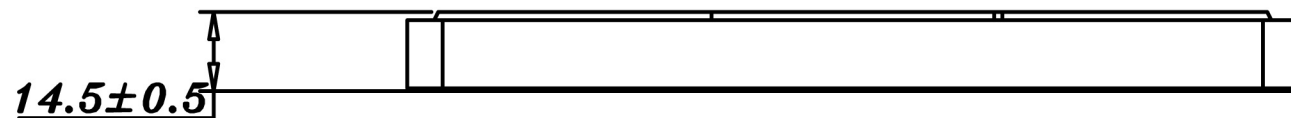
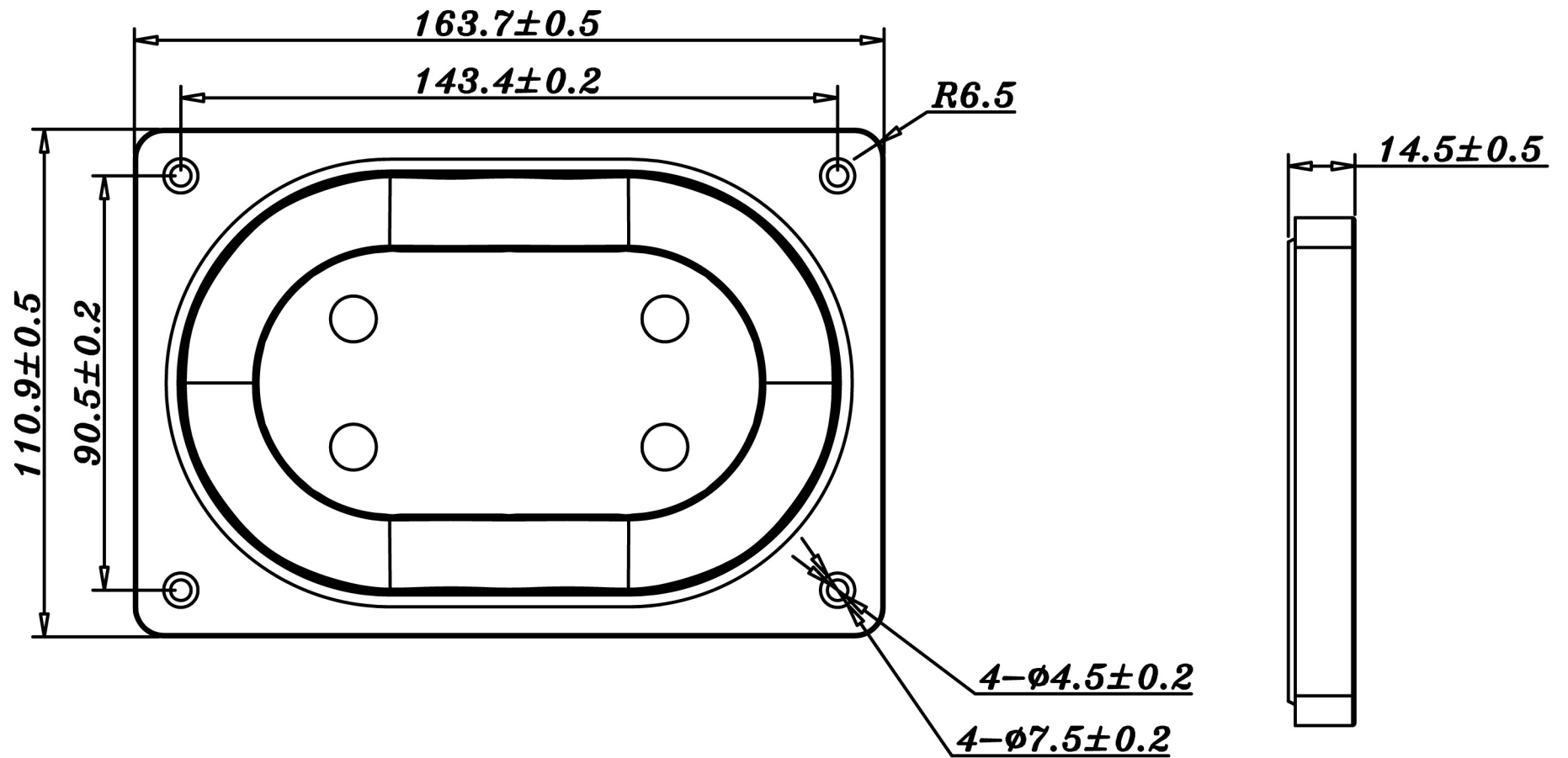

Material(材质):Rubber



PR14

Rev:R01

Date : 2015-09-07