

# Custom Passive Radiator Box Design

By CJJ, TB

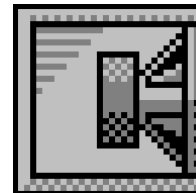

## Box Properties

--Description--

Name: W5-2053

Type: Passive Radiator Box

Shape: Prism, square

--Box Parameters--

Vb = 3 liters

V(total) = 3.361 liters

QL = 7

F3 = 38.49 Hz

Fill = minimal

--Passive Radiators--

No. of Passive Radiators = 1

Fs = 3.762 Hz

Qms = 4.615

Vas = 290.6 liters

Cms = 5.115 mm/N

Mms = 350 g

Rms = 1.792 kg/s

Sd = 200 sq.cm

## Driver Properties

--Description--

Name: W5-2053

Type: Standard one-way driver

--Configuration--

**No. of Drivers = 1**

--Driver Parameters--

Fs = 38.7 Hz

Qms = 4.7

Vas = 3.9 liters

Xmax = 7.9 mm

Sd = 75 sq.cm

Qes = 0.35

Re = 3.6 ohms

Le = 0.2 mH

Z = 4 ohms

Pe = 40 watts



### Wiring Diagram

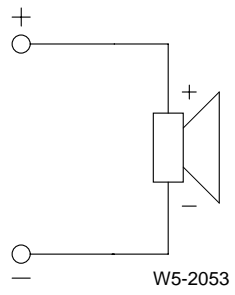

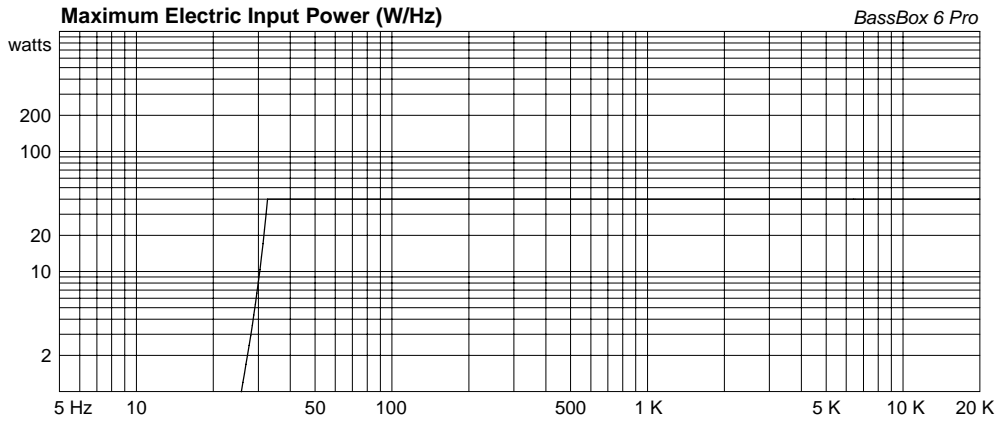
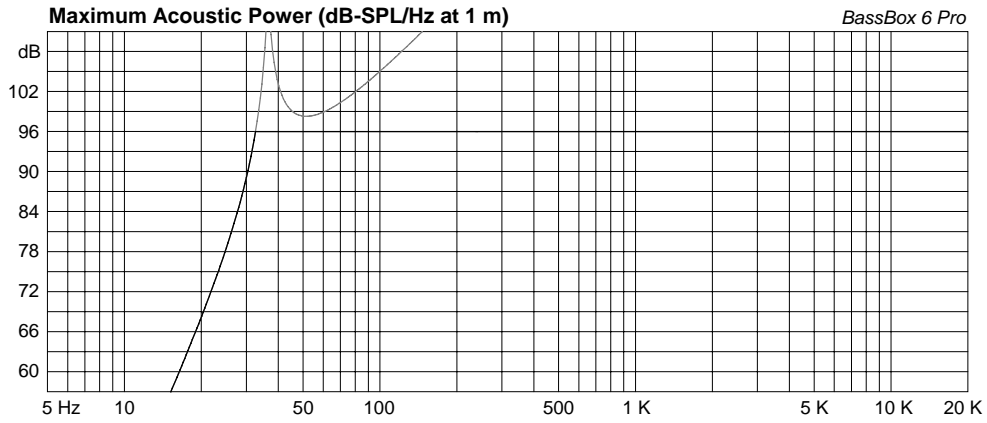
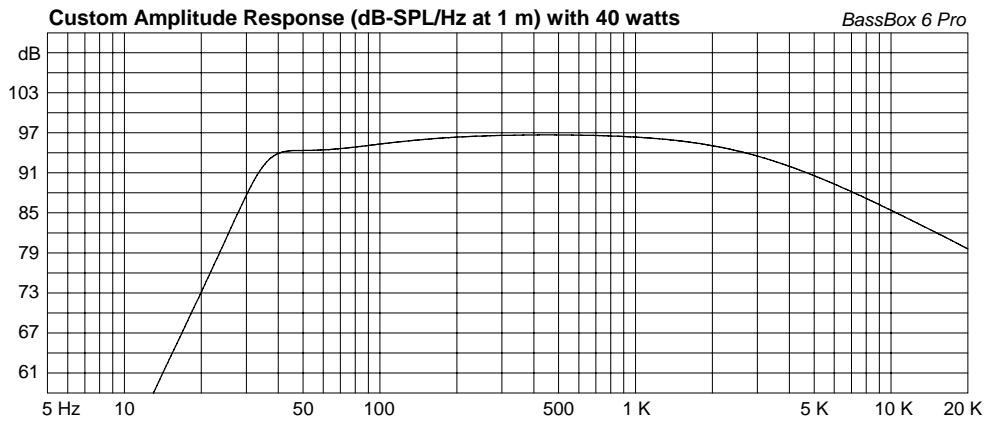
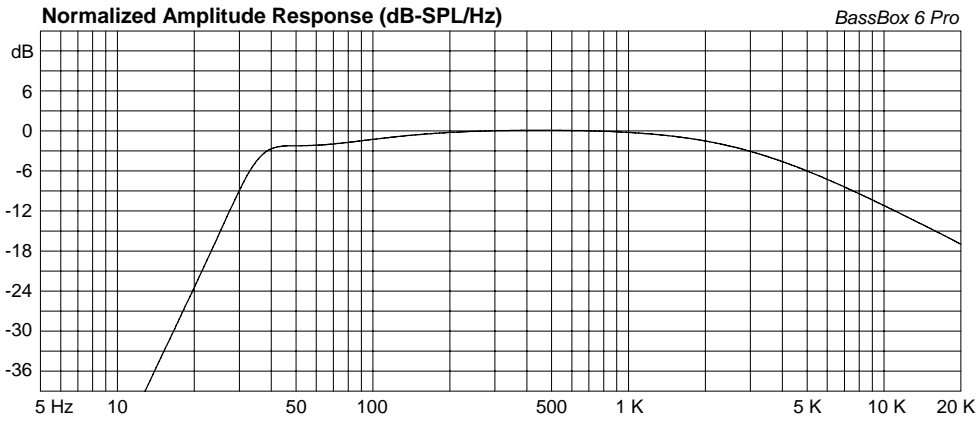

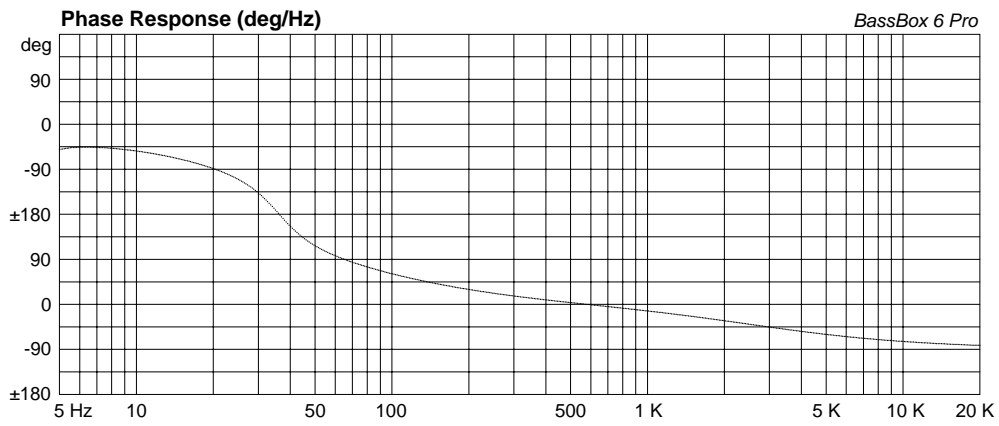
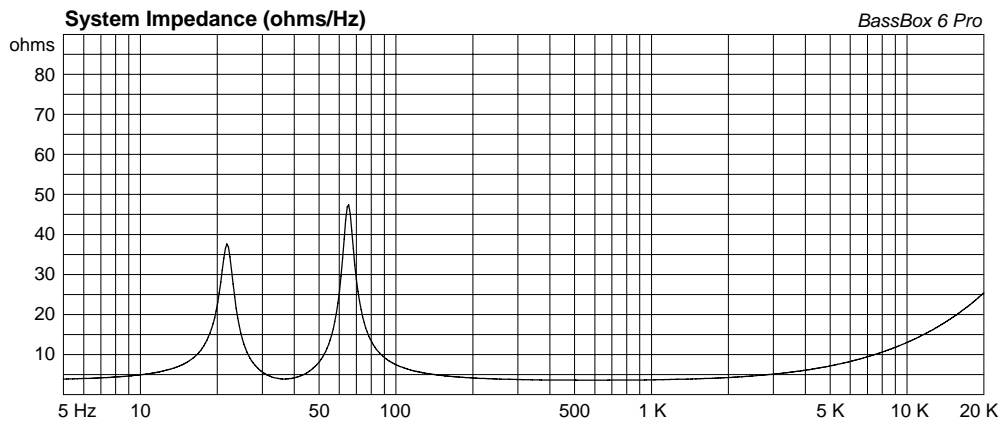
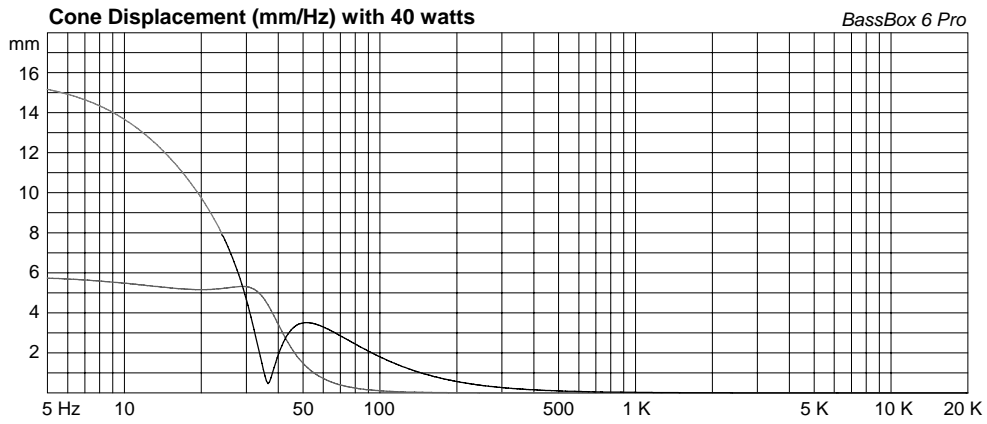

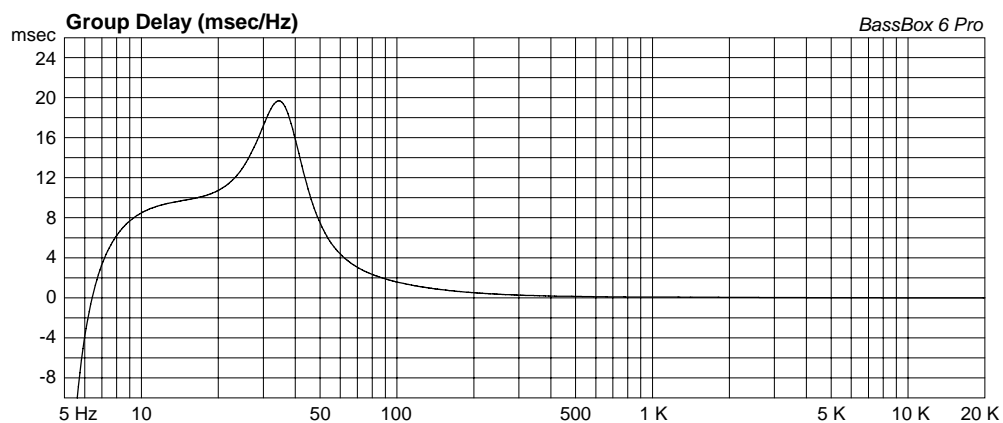

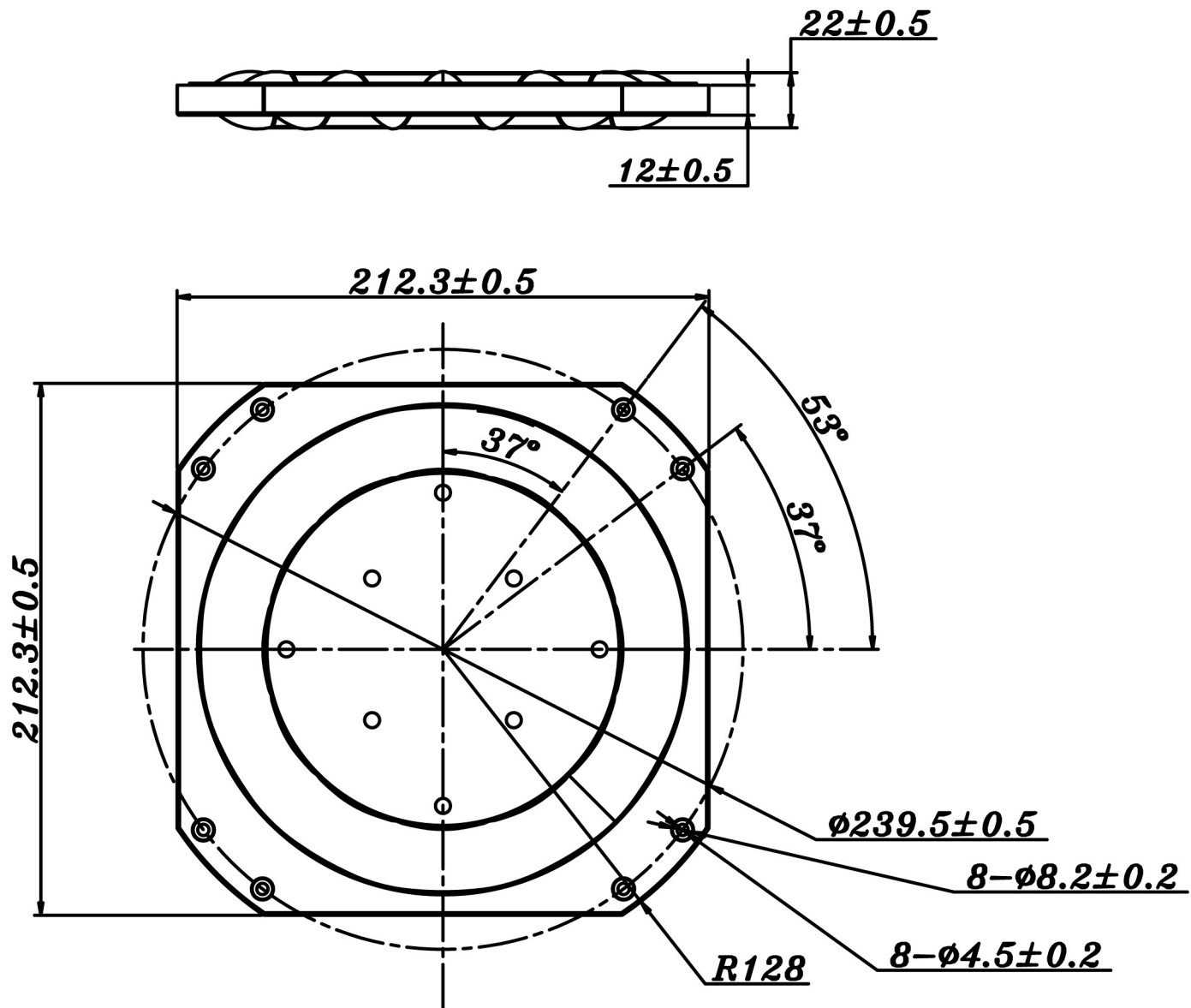

Material(材质):Rubber

**TS**  
speaker

**PR10**

Rev:R01

Date : 2015-09-07